

RDCD25SKCE

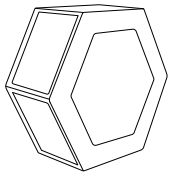

4BRF



Der Enthalpietauscher ist im Lieferumfang **Included** - Enthalpic heat exchanger

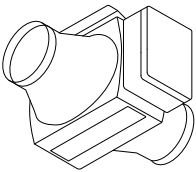

Optional - ECOFILTRIO PLUS

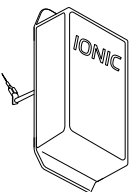

Optional - IONIC

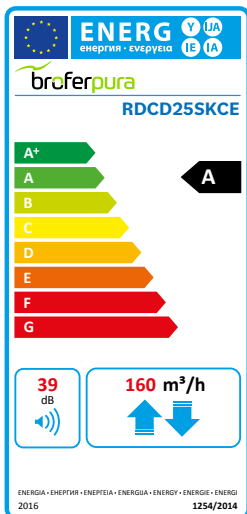

SEHR HOCHEFFIZIENTE ZENTRALISIERTE WÄRMERÜCKGEWINNUNGSEINHEIT FÜR PRIVATHAUSHALTE WIRELESS PLUG-AND-PLAY-EINSTELLUNG INKLUSIVE AUTOMATISCHEM BYPASS INKLUSIVE EINBAU HORIZONTAL-VERTIKAL-RECHTS-LINKS

Wärmerückgewinnungseinheit: Gegenstrom, vollständig aus Kunststoff. *Version mit Enthalpieaustauscher.*

Struktur: selbsttragend in wasserdichtem PPE, komplett mit Filterabsaugung. Außengehäuse aus vorlackiertem Blech mit schalldämpfender Isolierung.

Lüfter: Plug Lüfter mit EC bürstenlosem Motor mit einfacher Ansaugung.

Filter: Die Einheiten sind serienmäßig mit gewellten Filterzellen aus synthetischen Fasern der Klasse G4 ausgestattet, optional mit einem Hochleistungsfilter F7 für die Außenluft.

DOMESTIC CENTRALIZED HEAT RECOVERY UNIT WITH VERY HIGH EFFICIENCY AND WITH WIRELESS PLUG AND PLAY CONTROL SYSTEM INCLUDED AUTOMATIC BY-PASS INCLUDED INSTALLATION HORIZONTAL-VERTICAL-RIGHT -LEFT

Heat recovery: heat exchanger of the type in countercurrent entirely made of plastic material. *Version with enthalpic heat exchanger.*

Structure: free standing EPP seal, complete of filters ex traction system. External casing made by prepainted steel with sound proof insulation.

Fans: plug fan with EC Brushless engine single inlet.

Filters: the units are equipped with standard filter cells synthetic fiber efficiency G4, optional F7 efficiency on fresh air.

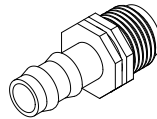

Vorbereitet für den Kondensatabfluss.
Predisposition for condensate drying.

Luftdurchsatz (mc/h) Nominal air flow (mc/h)	160
Statischer nutzbarer Druck (pa) Useful static pressure (pa)	100

DATEN FÜR JEDEN LÜFTER | DATA FOR EACH FAN

Nennleistung (W) Installed power (W)	27
Drehungen (1/min) Round (1/MIN)	3700
I Nennstrom (A) Current (A)	0.27
Spannung (V) Rated voltage (V)	230
Frequenz (Hz) Frequency (HZ)	50
Geschwindigkeit (nr) Speed (nr)	3+(1 booster)

FILTER | FILTERS

Wirkungsgrad Efficiency Standard	G4 ISO COARSE > 65 %
Wirkungsgrad Efficiency Optional	F7 ISO e PM1 > 65 %

ZEICHNUNGEN | DRAWINGS

GEWICHT | WEIGHT: 30 kg

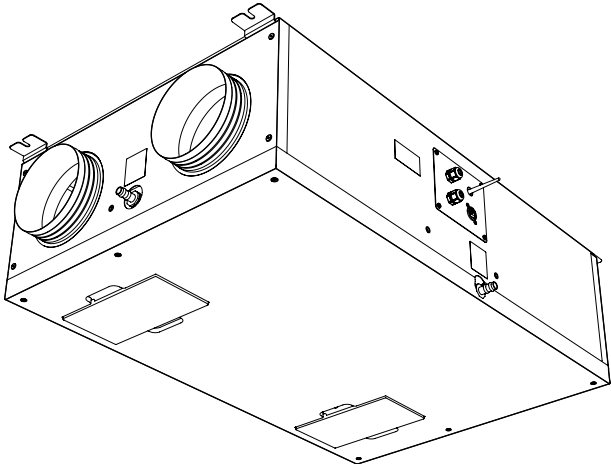

Ansicht von unten | Bottom View

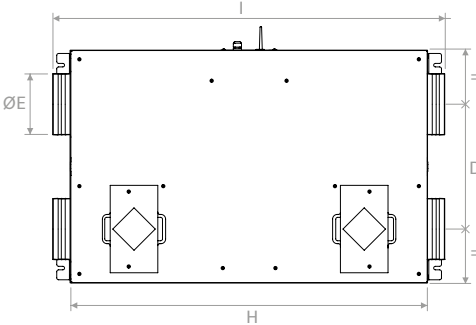

Innenansicht | Internal view

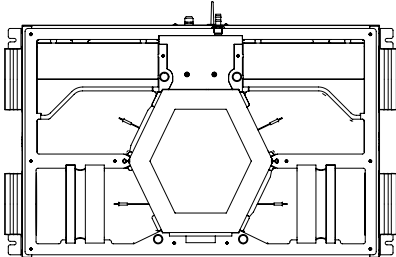

Seitenansicht | Side view

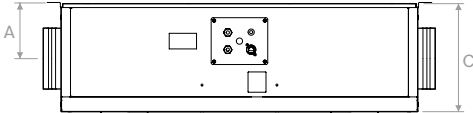

Frontansicht | Front view

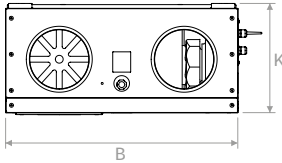

Draufsicht | Plan view

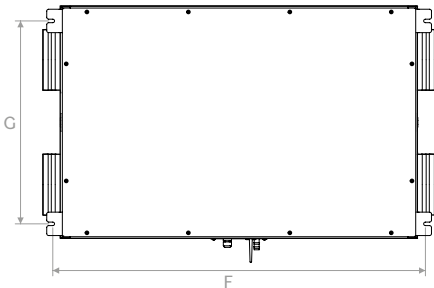

	A	B	C	D	ØE	F	G	H	I	K
mm	135	595	277	320	156	955	520	914	1005	282



ZERTIFIZIERTE LEISTUNGEN NACH EN 13141:7:2011 | PERFORMANCE EN 13141:7:2011 CERTIFIED

Statischer Druck
Useful static pressure
① ③

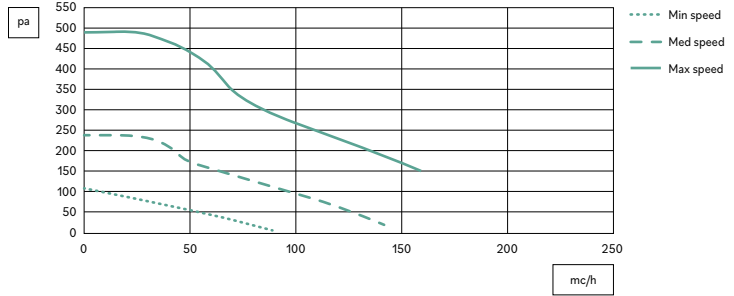

Spezifische Lüfterleistung
S.F.P.
②



Diagramm des sensiblen Wirkungsgrads im Winter
Außenluft: 25 °C
Raumluft: 5 °C
Winter sensible efficiency chart
Fresh air: 25 °C
Return air: 5 °C



Diagramm des latenten Wirkungsgrads im Winter
Außenluft: 5 °C - 79 % U.R.
Raumluft: 25 °C - 50 % U.R.
Winter latent efficiency chart
Fresh air: 5 °C - 79 % R.H.
Return air: 25 °C - 50 % R.H.

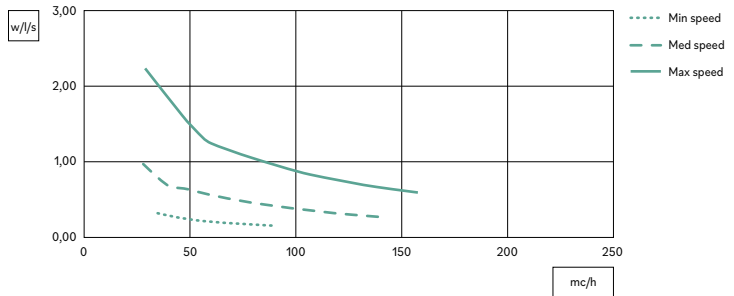

① Daten mit G4-Filter Standard | Data with standard G4 filters
 ② Daten für jeden Lüfter | Data for single fan
 ③ Druckabfall Filterwirkungsgrad F7 80 pa bei maximalem Durchfluss mit sauberem Filter
 Air pressure drop with F7 efficiency filter 80 pa at maximum air flow rate with clean filter

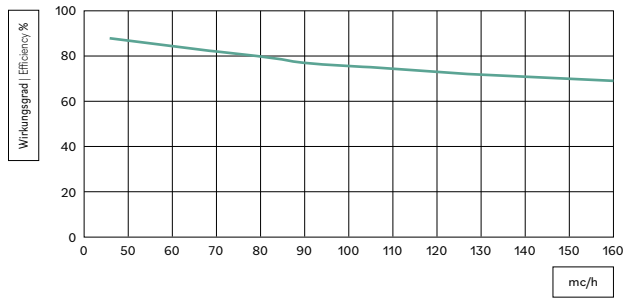
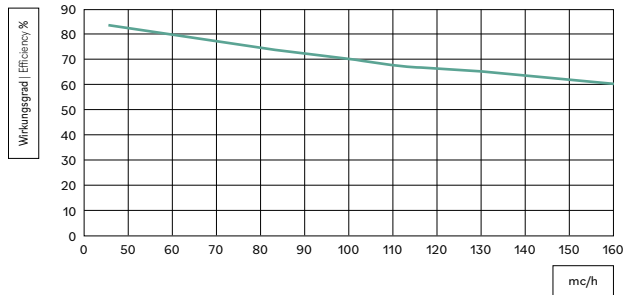

Diagramm des sensiblen Wirkungsgrads im Sommer
Außenluft: 35 °C
Raumluft: 25 °C
Summer sensible efficiency chart
Fresh air: 35 °C
Return air: 25 °C



Diagramm des latenten Wirkungsgrads im Sommer
Außenluft: 35 °C - 57 % U.R.
Raumluft: 25 °C - 50 % U.R.
Summer latent efficiency chart
Fresh air: 35 °C - 57 % R.H.
Return air: 25 °C - 50 % R.H.



VERTIKALER WANDEINBAU | VERTICAL WALL INSTALLATION

Typ | Type A (Standard)

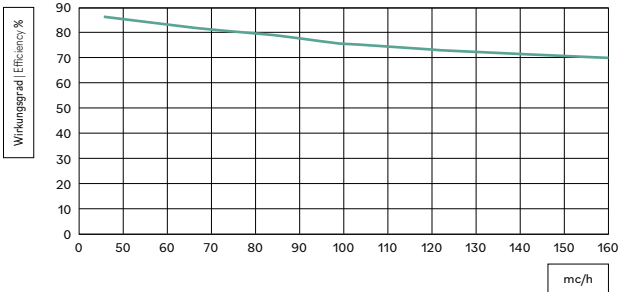
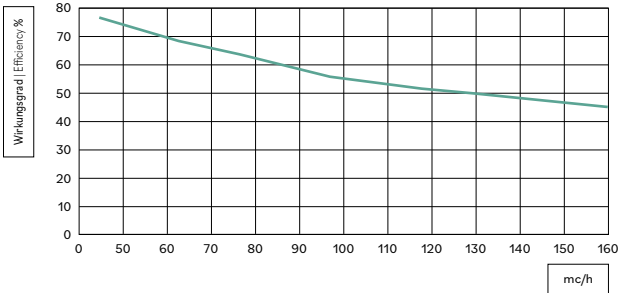

Typ | Type B



HORIZONTALER DECKENEINBAU | HORIZONTAL CEILING INSTALLATION

Typ | Type A (Standard)



Typ | Type A1 (Standard)

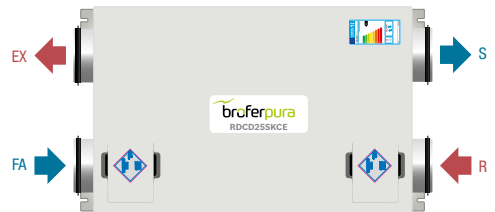

Typ | Type B

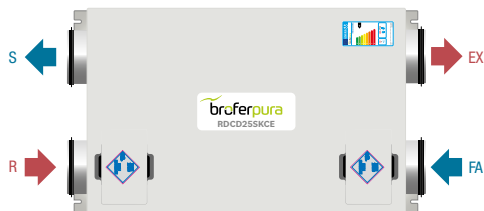

Typ | Type B1

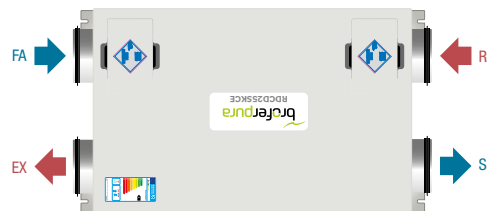

Legende | Legend

- EX = Abluft | exhaust air
- R = Rücklauf | return
- FA = Außenluft | fresh air
- S = Vorlauf | supply



LEISTUNGSERKLÄRUNG WÄRMERÜCKGEWINNUNGSEINHEIT

DECLARATION OF PERFORMANCE HEAT RECOVERY UNIT

Name oder Handelsname des Herstellers Supplier name or trade mark	BROFER								
Kennzeichnung des Lieferantenmodells und installierte Optionen Supplier Model Identifier and options installed	RDCD25SKCE + 4BRF			RDCD25SKCE + RHRF / CO2RF			RDCD25SKCE + RHRF / CO2RF lokal-local		
Bezugsklima Reference climate	gemäßigt Temperate	kalt Cold	warm Hot	gemäßigt Temperate	kalt Cold	warm Hot	gemäßigt Temperate	kalt Cold	warm Hot
SEC in [kWh/(m ² a)] für jede Art von Klima (gemäßigt, heiß, kalt) for each type of climate (temperate, hot, cold)	-34,16	-73,26	-11,77	-37,12	-77,38	-14,06	-40,62	-82,44	-16,67
SEC Class	A	A+	E	A	A+	E	A	A+	E
Angegebener Typ der Belüftungseinheit Declared Typology	UVR-B Bidirektional UVR-B Bidirectional			UVR-B Bidirektional UVR-B Bidirectional			UVR-B Bidirektional UVR-B Bidirectional		
Typ des installierten Antriebs Type of drive installed	Mehrstufiger Antrieb Multi-speed drive			Variable Geschwindigkeit Variable speed			Variable Geschwindigkeit Variable speed		
Art des Wärmerückgewinnungssystems Type of heat recovery	Rückgewinnung Recuperative			Rückgewinnung Recuperative			Rückgewinnung Recuperative		
Thermischer Wirkungsgrad ¹ Thermal efficiency ¹	74,5%			74,5%			74,5%		
Maximale Durchflussmenge in [m ³ /h] ² Maximum flow rate in [m ³ /h] ²	160			160			160		
Maximale elektrische Gesamtleistung in [W] Maximum electric Power in [W]	60			60			60		
Schalleistungspegel (LWA) in [dB(A)] ³ Sound Power Level (LWA) in [dB(A)] ³	39			39			39		
Referenz-Durchflussmenge in [m ³ /h] ⁴ Reference flow rate [m ³ /h] ⁴	112			112			112		
Referenzdruckdifferenzen [Pa] Reference pressure difference in [Pa]	50			50			50		
SPI in [W/m ³ /h] ⁵	0,21			0,21			0,21		
Kontrollfaktor und Typologie Control factor and typology	1			0,85			0,65		
Maximale interne Leckage in Prozent [%] ⁶ Declared maximum internal leakage [%] ⁶	1,2			1,2			1,2		
Maximale externe Leckagerate [%] ⁶ Declared maximum external leakage [%] ⁶	2,5			2,5			2,5		
Internetadresse mit Konstruktionen Internet address for pre/dis-assembly instruction	www.broferpura.it								

1: Wirkungsgrad gemäß EN13141-7:2010 bei Referenzdurchfluss bei 50 Pa | Efficiency according EN13141-7:2010 at reference flow at 50 Pa
 2: Maximaler Durchfluss bei 100 Pa Außendruck | Maximum flow at 100 Pa external pressure
 3: Gehäuseabstrahlung bei Referenzdurchflussmenge bei 50 Pa Außendruck | Casing radiation at reference flow rate at 50 Pa external pressure
 4: Der Referenzdurchfluss beträgt 70% des maximalen Durchflusses bei 50 Pa Außendruck gemäß EN13141-7:2010
 Reference flow rate is 70% of maximum flow at 50 Pa external pressure according EN13141-7:2010
 5: In Übereinstimmung mit EN13141-7:2010 bei Referenzdurchfluss | According EN13141-7:2010 at reference flow rate
 6: Nach EN13141-7:2010 | According EN13141-7:2010
 SEC: Spezifischer Energieverbrauch | Specific Energy Consumption









RDCD25SKCE

CODES | CODES

Modell Model	Beschreibung Description
RDCD25SKCE	
RDCD25SKBE*	
KFTR060A	Ersatzfiltersatz (2 Stück) Wirkungsgrad G4 Replacement filter kit (2 pcs) efficiency G4
FTRLET483	Ersatzfilter Wirkungsgrad F7 Replacement filter efficiency F7

* Version mit Elektrobatterie im Gerät | Version with electric battery inside the unit

	4BRF	RHRF	CO2RF	MODBUSRF	APPRF	DSPRF
Modell Model						
Kontrolle der Geschwindigkeit Speed control	●	●	●		●	●
By-pass	●	●	●		●	●
Frostschutzmittel Defrost protection	●	●	●		●	●
Filter verstopft Clogged filters	●	●	●		●	●
Kontrolle der Feuchte Humidity control		●				
Kontrolle CO ₂ CO ₂ control			●			
Booster-Fuktion Booster function	●				●	●
MODBUS-Sender MODBUS gate way				●	●	
Einstellung der Geschwindigkeit Speeds setting						●
ON/OFF						●
Einstellung der Geschwindigkeit Punctual alarms	●	●	●			●



ZUBEHÖR | ACCESSORIES

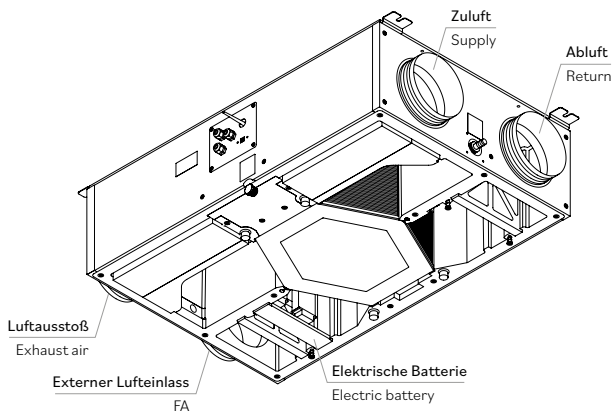

RDCD25SKCBE - RDCD25SKCEBE

1 kw - 230 V - 50 Hz Elektrobatterie im Gerät integriert
 Electric battery 1 kw - 230 V - 50 Hz integrated in the unit

Batteriesteuerung durch die Geräteplatine
 Battery controlled by PCB of the unit

System nach Geräteauslieferung nicht mehr verfügbar
 System not available after unit delivery

