

# RDCD50SH

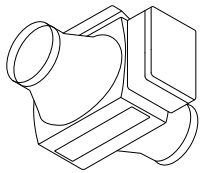

Optional - ECOFILTRO PLUS

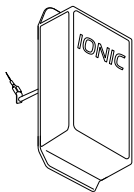

Optional - IONIC

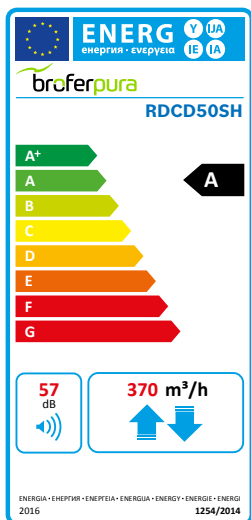

4BRF



## SEHR HOCHEFFIZIENTE ZENTRALISIERTE WÄRMERÜCKGEWINNUNGSEINHEIT FÜR PRIVATHAUSHALTE WIRELESS PLUG-AND-PLAY-EINSTELLUNG INKLUSIVE AUTOMATISCHEM BYPASS INKLUSIVE

**Wärmerückgewinnungseinheit:** Gegenstrom, vollständig aus Kunststoff.

**Struktur:** selbsttragend in wasserdichtem EPS, komplett mit Filterabsaugung und Kondensatabfuhr.

**Lüfter:** Plug Lüfter mit EC bürstenlosem Motor.

**Filter:** Die Einheiten sind serienmäßig mit gewellten Filterzellen aus synthetischen Fasern der Klasse G4 ausgestattet, optional mit einem Hochleistungsfilter F7 für die Außenluft.

## DOMESTIC CENTRALIZED HEAT RECOVERY UNIT WITH VERY HIGH EFFICIENCY AND WITH WIRELESS PLUG AND PLAY CONTROL SYSTEM INCLUDED AUTOMATIC BY-PASS INCLUDED

**Heat recovery:** heat exchanger of the type in countercurrent entirely made of plastic material.

**Structure:** free standing EPS seal with outer coat painted steel complete of filters extraction system and drain condensate.

**Fans:** plug fan type with EC Brushless engine.

**Filters:** the units are equipped with standard filter cells synthetic fiber efficiency G4, optional F7 efficiency on fresh air.

Luftdurchsatz (mc/h)   Nominal air flow (mc/h)	370
Statischer nutzbarer Druck (pa)   Useful static pressure (pa)	100

### DATEN FÜR JEDEN LÜFTER | DATA FOR EACH FAN

Nennleistung (w)   Installed power (W)	83
I Nennstrom (A)   Current (A)	0,75
Spannung (V)   Rated voltage (V)	230
Frequenz (Hz)   Frequency (HZ)	50
Geschwindigkeit (nr)   Speed (nr)	3+(1 booster)

### FILTER | FILTERS

Wirkungsgrad   Efficiency Standard	G4 ISO COARSE > 65 %
Wirkungsgrad   Efficiency Optional	F7 ISO e PM1 > 65 %



**ZEICHNUNGEN | DRAWINGS**

GEWICHT | WEIGHT: 41 kg

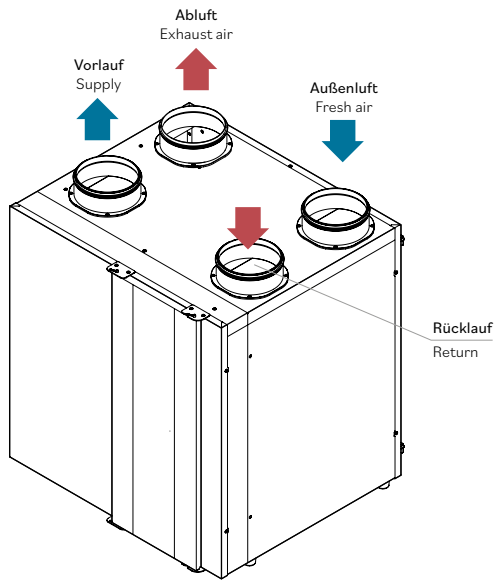

Frontansicht | Front view

Seitenansicht | Side view

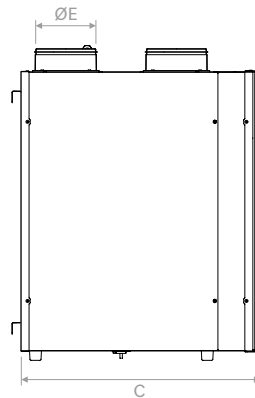
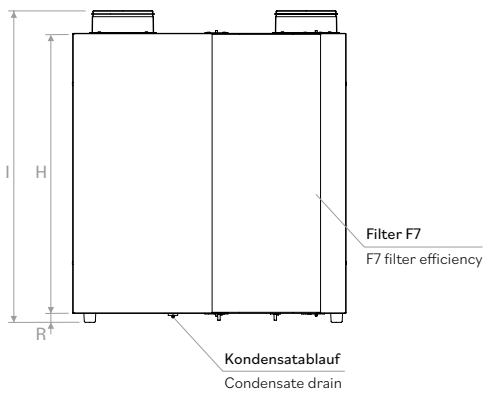

Ansicht von oben | Top view

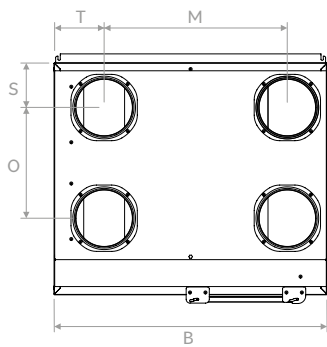

	B	C	H	ØE	I	M	O	R	S	T
mm	702	617	722	160	808	475	287	24	199	128



ZERTIFIZIERTE LEISTUNGEN NACH EN 13141:7:2011 | PERFORMANCE EN 13141:7:2011 CERTIFIED

**Statischer Druck**  
Useful static pressure  
① ③

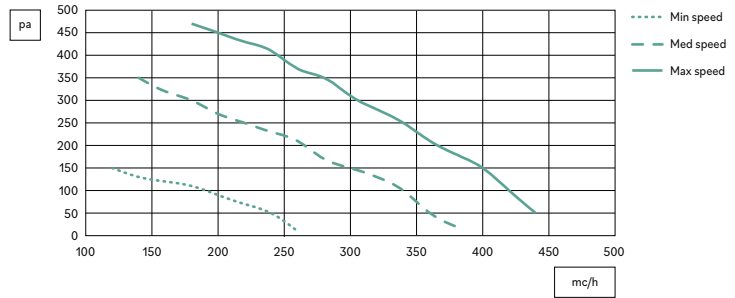

**Spezifische Lüfterleistung**  
S.F.P.  
②

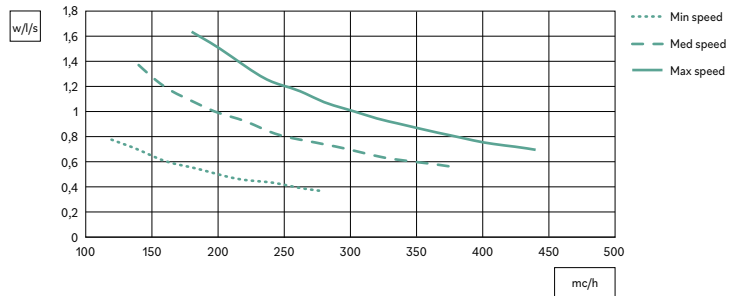

ZERTIFIZIERTER WÄRMETAUSCHER NACH EN 13147:7:2011 | HEAT EXCHANGER EN 13147:7:2011 CERTIFIED

**Diagramm Wirkungsgrad im Sommer**  
Außenluft: 32 °C / 50 % U.R.  
Raumluft: 26 °C / 50 % U.R.  
**Summer efficiency chart**  
Fresh air: 32 °C / 50 % R.H.  
Return air: 26 °C / 50 % R.H.

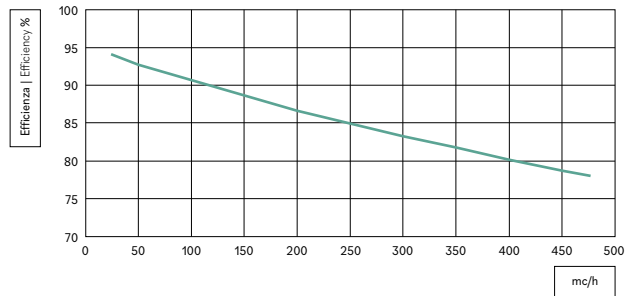

**Diagramm Wirkungsgrad im Winter**  
Außenluft: -5 °C / 80 % U.R.  
Raumluft: 20 °C / 50 % U.R.  
**Winter efficiency chart**  
Fresh air: -5 °C / 80 % R.H.  
Return air: 20 °C / 50 % R.H.

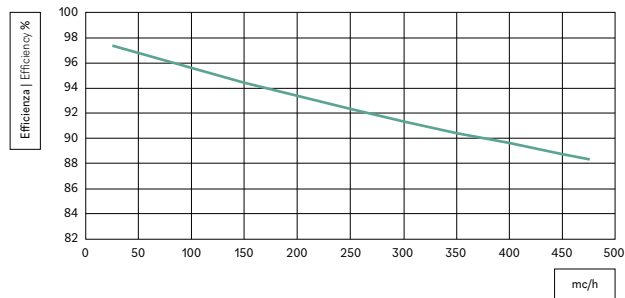

- ① Daten mit G4-Filter Standard | Data with standard G4 filters
- ② Daten für jeden Lüfter | Data for single fan
- ③ Druckabfall Filterwirkungsgrad F7 80 pa bei maximalem Durchfluss mit sauberem Filter  
Air pressure drop with F7 efficiency filter 80 pa at maximum air flow rate with clean filter



**ABGESTRAHLTER SCHALLPEGEL | RADIATED SOUND LEVEL**

---

<b>GESCHWIDIGKEIT   SPEED</b>		<b>SCHALLDRUCK   SOUND PRESSURE</b>							
<b>Hz</b>	<b>63</b>	<b>125</b>	<b>250</b>	<b>500</b>	<b>1000</b>	<b>2000</b>	<b>4000</b>	<b>8000</b>	
10V	24	30	48	52	50	47	41	40	dB (A)
8V	21	32	47	51	47	45	39	37	dB (A)
6V	21	28	46	45	38	38	32	27	dB (A)

## LEISTUNGSERKLÄRUNG WÄRMERÜCKGEWINNUNGSEINHEIT

### DECLARATION OF PERFORMANCE HEAT RECOVERY UNIT

Name oder Handelsname des Herstellers Supplier name or trade mark	BROFER								
Kennzeichnung des Lieferantenmodells und installierte Optionen Supplier Model Identifier and options installed	RDCD50SH + 4BRF			RDCD50SH + RHRF / CO2RF			RDCD50SH + RHRF / CO2RF lokal-local		
Bezugsklima Reference climate	gemäßigt Temperate	kalt Cold	warm Hot	gemäßigt Temperate	kalt Cold	warm Hot	gemäßigt Temperate	kalt Cold	warm Hot
SEC in [kWh/(m <sup>2</sup> a)] für jede Art von Klima (gemäßigt, heiß, kalt) for each type of climate (temperate, hot, cold)	-37,41	-76	-12,67	-40,12	-79,15	-15,14	-43,16	-82,77	-17,74
SEC Class	A	A+	F	A	A+	F	A	A+	E
Angegebener Typ der Belüftungseinheit Declared Typology	UVR-B Bidirektional UVR-B Bidirectional			UVR-B Bidirektional UVR-B Bidirectional			UVR-B Bidirektional UVR-B Bidirectional		
Typ des installierten Antriebs Type of drive installed	Variable Geschwindigkeit Variable speed			Variable Geschwindigkeit Variable speed			Variable Geschwindigkeit Variable speed		
Art des Wärmerückgewinnungssystems Type of heat recovery	Rückgewinnung Recuperative			Rückgewinnung Recuperative			Rückgewinnung Recuperative		
Thermischer Wirkungsgrad <sup>1</sup> Thermal efficiency <sup>1</sup>	90,5			90,5			90,5		
Maximale Durchflussmenge in [m <sup>3</sup> /h] <sup>2</sup> Maximum flow rate in [m <sup>3</sup> /h] <sup>2</sup>	370			370			370		
Maximale elektrische Gesamtleistung in [W] Maximum electric Power in [W]	169			169			169		
Schalleistungspegel (LWA) in [dB(A)] <sup>3</sup> Sound Power Level (LWA) in [dB(A)] <sup>3</sup>	57,3			57,3			57,3		
Referenz-Durchflussmenge in [m <sup>3</sup> /h] <sup>4</sup> Reference flow rate [m <sup>3</sup> /h] <sup>4</sup>	259			259			259		
Referenzdruckdifferenzen [Pa] Reference pressure difference in [Pa]	50			50			50		
SPI in [W/m <sup>3</sup> /h] <sup>5</sup>	0,259			0,259			0,259		
Kontrollfaktor und Typologie Control factor and typology	1			0,85			0,65		
Maximale interne Leckage in Prozent [%] <sup>6</sup> Declared maximum internal leakage [%] <sup>6</sup>	0,3			0,3			0,3		
Maximale externe Leckagerate [%] <sup>6</sup> Declared maximum external leakage [%] <sup>6</sup>	0,4			0,4			0,4		
SEC gemäßigt Klima (kWh Strom/Jahr) SEC Temperate climate (kWh electricity/annum)	359			272			178		
AHS (Primärenergie kWh/Jahr) AHS (kWh primary energy/annum)	4.598	8.995	2.079	4.653	9.083	2.100	4.704	9.202	2.127
Internetadresse mit Konstruktionen Internet address for pre/dis-assembly instruction	www.broferpura.it								

1: Wirkungsgrad gemäß EN13141-7:2010 bei Referenzdurchfluss bei 50 Pa | Efficiency according EN13141-7:2010 at reference flow at 50 Pa  
2: Maximaler Durchfluss bei 100 Pa Außendruck | Maximum flow at 100 Pa external pressure  
3: Gehäuseabstrahlung bei Referenzdurchflussmenge bei 50 Pa Außendruck | Casing radiation at reference flow rate at 50 Pa external pressure  
4: Der Referenzdurchfluss beträgt 70% des maximalen Durchflusses bei 50 Pa Außendruck gemäß EN13141-7:2010  
Reference flow rate is 70% of maximum flow at 50 Pa external pressure according EN13141-7:2010  
5: In Übereinstimmung mit EN13141-7:2010 bei Referenzdurchfluss | According EN13141-7:2010 at reference flow rate  
6: Nach EN13141-7:2011 | According EN13141-7:2010  
SEC: Spezifischer Energieverbrauch | Specific Energy Consumption









**CODES | CODES**

Modell   Model	Beschreibung   Description
<b>RDCD50SH</b>	
<b>RDCD50SHE*</b>	
<b>RDCD50SHI**</b>	Abmessungen   Sizes pag. 268
<b>FTRSV23</b>	Ersatzfiltersatz (2 Stück) Wirkungsgrad G4   Replacement filter kit (2 pcs) efficiency G4
<b>FTRSV48</b>	Ersatzfilter Wirkungsgrad F7   Replacement filter efficiency F7

\* Version mit Enthalpie-Rückgewinnung | Version with enthalpic heat exchanger

\*\* Version komplett mit IONIC-Ionisator | Version complete with IONIC ionizer

	<b>4BRF</b>	<b>RHRF</b>	<b>CO2RF</b>	<b>MODBUSRF</b>	<b>APPRF</b>	<b>DSPRF</b>
Modell Model						
Kontrolle der Geschwindigkeit Speed control	●	●	●		●	●
By-pass	●	●	●		●	●
Frostschutzmittel Defrost protection	●	●	●		●	●
Filter verstopft Clogged filters	●	●	●		●	●
Kontrolle der Feuchte Humidity control		●				
Kontrolle CO <sub>2</sub> CO <sub>2</sub> control			●			
Booster-Fuktion Booster function	●				●	●
MODBUS-Sender MODBUS gate way				●	●	
Einstellung der Geschwindigkeit Speeds setting						●
ON/OFF						●
Pünktliche Alarme Punctual alarms	●	●	●			●

