

RDCD70SH

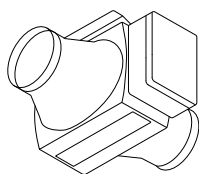

Optional - ECOFILTRO PLUS

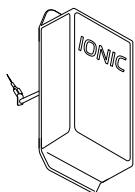

Optional - IONIC



4BRF



UNIDAD DOMÉSTICA DE RECUPERACIÓN DEL CALOR CENTRALIZADA DE EFICIENCIA MUY ALTA AJUSTE PLUG AND PLAY INALÁMBRICO INCLUIDO BY-PASS AUTOMÁTICO INCLUIDO

Recuperador del calor: conectorriente totalmente realizado en material plástico.

Estructura: autoportante de EPS estanca con capa externa de acero y con sistema de extracción de filtros y drenaje de condensación.

Ventiladores: plug fan con motores EC sin escobillas.

Filtros: las unidades vienen equipadas de serie con celdas filtrantes onduladas de fibra sintética de tipo G4, con opción de filtro de eficiencia F7 en aire exterior.

DOMESTIC CENTRALIZED HEAT RECOVERY UNIT WITH VERY HIGH EFFICIENCY AND WITH WIRELESS PLUG AND PLAY CONTROL SYSTEM INCLUDED AUTOMATIC BY-PASS INCLUDED

Heat recovery: heat exchanger of the type in countercurrent entirely made of plastic material.

Structure: free standing EPS seal with outer coat painted steel complete of filters extraction system and drain condensate.

Fans: plug fan type with EC Brushless engine.

Filters: the units are equipped with standard filter cells synthetic fiber efficiency G4, optional F7 efficiency on fresh air.

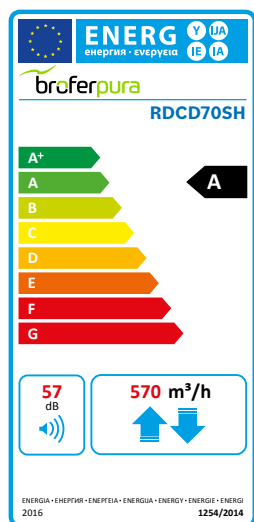

Caudal de aire (m ³ / h) Nominal air flow (mc/h)	570
Presión estática útil (pa) Useful static pressure (pa)	100

VENTILADOR DIRECTAMENTE ACOPLADO | DATA FOR EACH FAN

Potencia nominal (W) Installed power (W)	169
I nominal (A) Current (A)	1,5
Tensión (V) Rated voltage (V)	230
Frecuencia (Hz) Frequency (HZ)	50
Velocidad (n.º) Speed (nr)	3+(1 booster)

FILTROS | FILTERS

Eficiencia Efficiency Standard	G4 ISO COARSE > 65 %
Eficiencia Efficiency Optional	F7 ISO e PM1 > 65 %



DISEÑOS | DRAWINGS

PESO | WEIGHT: 41 kg

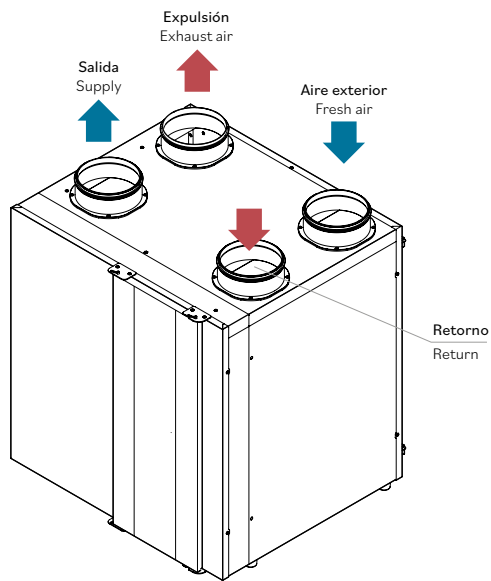

Vista frontal | Front view

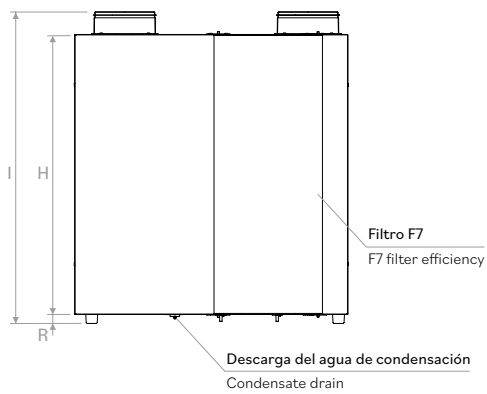

Vista lateral | Side view

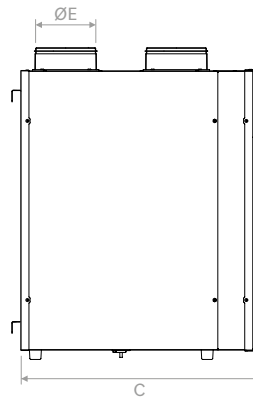

Vista superior | Top view

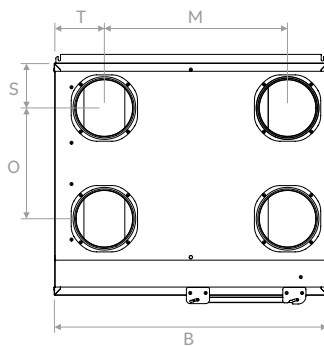

	B	C	H	ØE	I	M	O	R	T	S
mm	702	617	722	200	838	475	287	24	128	199



DIAGRAMAS DE RENDIMIENTO | PERFORMANCE CHARTS

PRESTACIONES CERTIFICADAS EN 13141:7:2011 | PERFORMANCE EN 13141:7:2011 CERTIFIED

Presión estática útil
Useful static pressure
① ③

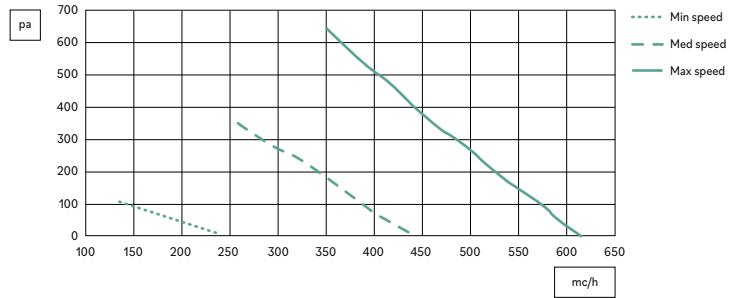

Potencia específica del ventilador
S.F.P.
②

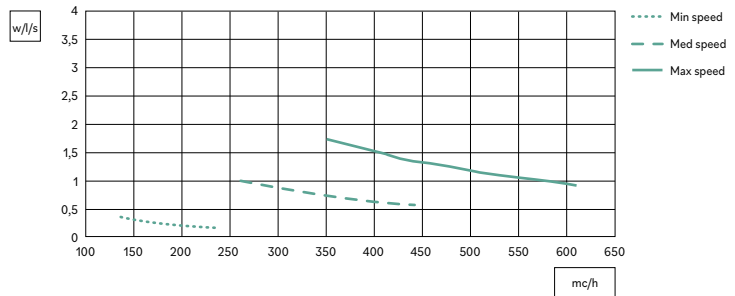

INTERCAMBIADOR CERTIFICADO EN 308 | HEAT EXCHANGER EN 13147:7:2011 CERTIFIED

Diagrama de eficiencia en verano
Aire exterior: 32 °C / 50 % de HR
Aire ambiente: 26 °C / 50 % de HR
Summer efficiency chart
Fresh air: 32 °C / 50 % R.H.
Return air: 26 °C / 50 % R.H.



Diagrama de eficiencia en invierno
Aire exterior: - 5 °C / 80 % de HR
Aire ambiente: 20 °C / 50 % de HR
Winter efficiency chart
Fresh air: -5 °C / 80 % R.H.
Return air: 20 °C / 50 % R.H.



- ① Datos con filtros G4 estándar | Data with standard G4 filters
- ② Datos por cada ventilador | Data for single fan
- ③ Pérdidas de carga del filtro de eficiencia F7 80 pa con el máximo caudal y con filtro limpio
Air pressure drop with F7 efficiency filter 80 pa at maximum air flow rate with clean filter

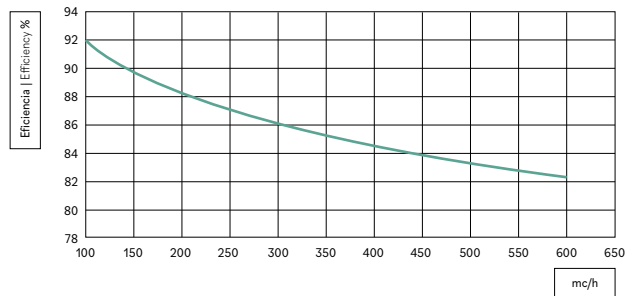
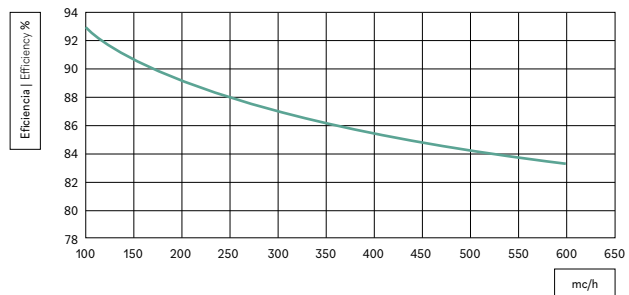

NIVEL DE SONIDO EMITIDO | RADIATED SOUND LEVEL

VELOCIDAD SPEED		PRESIÓN SONORA SOUND PRESSURE							
Hz	63	125	250	500	1000	2000	4000	8000	
10V	29	35	49	53	54	52	45	37	dB (A)
7V	26	33	43	43	43	42	36	29	dB (A)
4V	23	24	32	32	30	28	17	14	dB (A)

RDCD70SH

DECLARACIÓN DE RENDIMIENTO DE LA UNIDAD DE RECUPERACIÓN DEL CALOR

DECLARATION OF PERFORMANCE HEAT RECOVERY UNIT

Nombre o denominación comercial del fabricante Supplier name or trade mark	BROFER								
Identificador del modelo del proveedor y opciones instaladas Supplier Model Identifier and options installed	RDCD70SH + 4BRF			RDCD70SH + RHRF / CO2RF			RDCD70SH + RHRF / CO2RF locali-local		
Clima de referencia Reference climate	Templado Temperate	Frio Cold	Cálido Hot	Templado Temperate	Frio Cold	Cálido Hot	Templado Temperate	Frio Cold	Cálido Hot
SEC en [kWh / (m ² a)] para cada tipo de clima (templado, cálido, frío) for each type of climate (temperate, hot, cold)	-33,54	-76,50	-8,93	-37,19	-80,73	-12,24	-41,28	-85,61	-15,89
SEC Class	B	A+	F	A	A+	E	A	A+	E
Tipo declarado de la unidad de ventilación Declared Typology	UVR-B bidireccional UVR-B Bidirectional			UVR-B bidireccional UVR-B Bidirectional			UVR-B bidireccional UVR-B Bidirectional		
Tipo de accionamiento instalado Type of drive installed	Velocidad variable Variable speed			Velocidad variable Variable speed			Velocidad variable Variable speed		
Tipo de sistema de recuperación del calor Type of heat recovery	con recuperación Recuperative			con recuperación Recuperative			con recuperación Recuperative		
Eficiencia térmica ¹ Thermal efficiency ¹	87,2			87,2			87,2		
Caudal máximo en [m ³ / h] ² Maximum flow rate in [m ³ /h] ²	570			570			570		
Potencia eléctrica total con caudal máximo [W] Maximum electric Power in [W]	333			333			333		
Nivel de potencia acústica (LWA) en [dB(A)] ³ Sound Power Level (LWA) in [dB(A)] ³	57			57			57		
Caudal de referencia en [m ³ / h] ⁴ Reference flow rate [m ³ /h] ⁴	399			399			399		
Diferencias de presión de referencia [Pa] Reference pressure difference in [Pa]	50			50			50		
SPI in [W/m ³ /h] ⁵	0,349			0,349			0,345		
Factor de control y tipología Control factor and typology	1			0,85			0,65		
Porcentaje máximo de fugas internas [%] ⁶ Declared maximum internal leakage [%] ⁶	1,24			1,24			1,24		
Porcentaje máximo de fugas externas [%] ⁶ Declared maximum esternal leakage [%] ⁶	0,85			0,85			0,85		
Dirección de internet con montajes Internet address for pre/dis-assembly instruction	www.broferpura.it								

- 1: Eficiencia de acuerdo con EN13141-7:2010 del caudal de referencia a 50 Pa | Efficiency according EN13141-7:2010 at reference flow at 50 Pa
2: Caudal máximo a 100 Pa de presión externa | Maximum flow at 100 Pa external pressure
3: Emisión desde la caja hasta el caudal de referencia a 50 Pa de presión externa | Casing radiation at reference flow rate at 50 Pa external pressure
4: El porcentaje del caudal de referencia es del 70 % del caudal máximo a 50 Pa de presión externa de acuerdo con EN13141-7:2010
Reference flow rate is 70% of maximum flow at 50 Pa external pressure according EN13141-7:2010
5: De acuerdo con EN13141-7:2010 del caudal de referencia | According EN13141-7:2010 at reference flow rate
6: De acuerdo con EN13141-7:2010 | According EN13141-7:2010
SEC: Consumo de energía específico | Specific Energy Consumption







CÓDIGOS | CODES

Modelo Model	Descripción Description
RDCD70SH	
RDCD70SHE*	
RDCD70SHI**	Dimensiones Sizes pag. 268
FTRSV23	Kit de filtros de recambio (2 uds.) de eficiencia G4 Replacement filter kit (2 pcs) efficiency G4
FTRSV48	Filtro de recambio de eficiencia F7 Replacement filter efficiency F7

* Versión con recuperador entálpico | Version with enthalpic heat exchanger

** Versión completa con ionizador IONIC | Version complete with IONIC ionizer

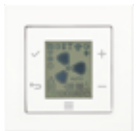
	4BRF	RHRF	CO2RF	MODBUSRF	APPRF	DSPRF
Modelo Model						
Control de la velocidad Speed control	●	●	●		●	●
By-pass	●	●	●		●	●
Anticongelante Defrost protection	●	●	●		●	●
Obstrucción de los filtros Clogged filters	●	●	●		●	●
Control de humedad Humidity control		●				
Control del CO ₂ CO ₂ control			●			
Función de máxima potencia Booster function	●				●	●
Transmisor MODBUS MODBUS gate way				●	●	
Ajuste de la velocidad Speeds setting						●
ON/OFF						●
Alarmas puntuales Punctual alarms	●	●	●			●

