

ECOFILTRO PLUS



ILH BERLIN
INSTITUT FÜR LUFTHYGIENE

ACCREDIA
UNITE FINANZIARIA ACCREDITAMENTO



MODULE DE FILTRATION A DISTANCE A TRES HAUT RENDEMENT POUR VMC

Caractéristiques : filtre électronique pour unité de récupération de chaleur domestique. Composé d'une grille de polarisation et de plaques de détection munies de cadre de support. Système électronique de génération et de commande. Plénum de confinement et raccord en matière plastique. Sécurité absolue avec déclenchement en phase de maintenance. Espace pour l'insertion du pré-filtre en option.

HIGH EFFICIENCY FILTRATION MODULE FOR VMC SYSTEMS

Characteristics: electronic filter for domestic heat recovery unit. Consisting of polarizing grille and collection plates complete support frame. Electronic system for generation and control. Containment and fitting plenum of plastic material. Absolute safety with release during maintenance. Space for prefilter installation optional.

DESCRIPTION PARAMÈTRES PARAMETER DESCRIPTION	UNITÉ DE MESURE UNIT OF MEASURE	VALEURS VALUES
Tension Rated voltage	V	230
Fréquence Frequency	Hz	50
Puissance nominale Installed power	W	9
Débit d'air maximal Maximum air flow rate	m ³ /h	420
Perte de charge maximale Maximum air pressure drop	Pa	34
Efficacité UNI 11254 ePM2,5 Efficiency UNI 11254 ePM2,5	%	90/95
Efficacité de la filtration bactérienne Bacterial filtration efficiency	%	> 90



DESSINS | DRAWINGS

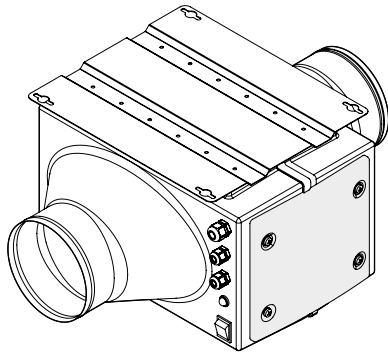

Vue isométrique de dessous
Isometric bottom view

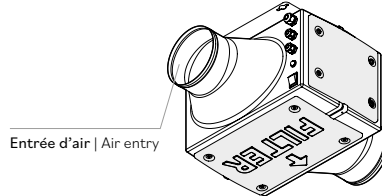

Vue isométrique vue du dessus
Isometric top view

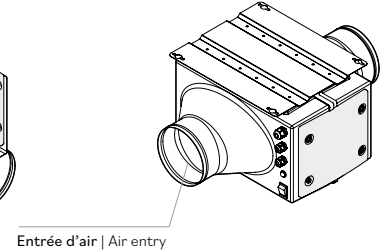

Vue inférieure | Bottom View

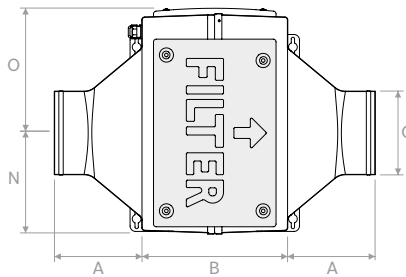

Vue frontale | Front view

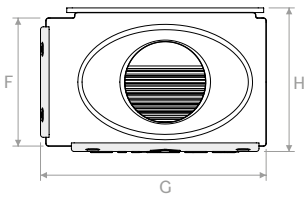

Vue latérale | Side view

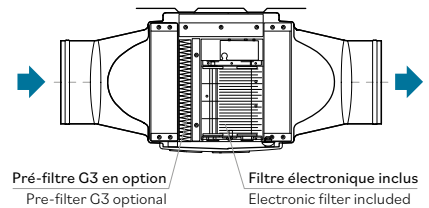
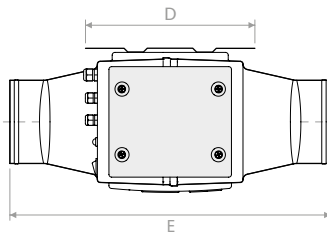

Vue de dessus | Top view

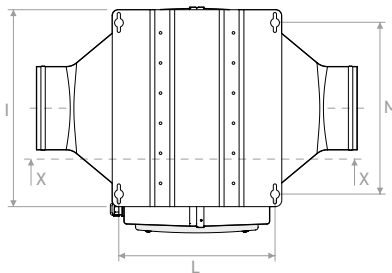

	A	B	C	D	E	F	G	H	I	L	M	N	O
mm	160	266	Ø 156	310	586	234	412	262	360	286	314	185	228

CODES | CODES

Modèle | Model

ECOFILTROPLUS

PF ECOFILTROPLUS*

* Refiltre d'efficacité G3 | Prefilter G3 efficiency.