



BRUCEC



UNITÀ DI RECUPERO CALORE DI TIPO COMMERCIALE AD ALTISSIMA EFFICIENZA

BY-PASS AUTOMATICO INCLUSO

MOTORI EC CON INVERTER

Recuperatore di calore: in controcorrente interamente realizzato in alluminio. In corrispondenza dello stesso è prevista una vasca per il drenaggio della condensa.

Struttura: il telaio portante è realizzato con profili di alluminio e pannellatura sandwich afonica. Le unità sono provviste di pannelli asportabili per accedere all'interno ed effettuare le operazioni di manutenzione ordinaria e straordinaria.

Ventilatori: plug fan con motore EC Brushless (modelli BRUCEC700, BRUCEC1000) centrifugo a doppia aspirazione con motore elettrico a rotore esterno EC Brushless direttamente accoppiato completo di inverter con interfaccia Modbus (modelli BRUCEC2000, BRUCEC3500, BRUCEC4500).

Filtri: le unità sono provviste di serie con celle filtranti ondulate in fibra sintetica classe G4, telaio in acciaio zincato e reti di protezione in filo di acciaio zincato elettrosaldato.

COMMERCIAL HEAT RECOVERY UNIT WITH VERY HIGH EFFICIENCY

AUTOMATIC BY-PASS INCLUDED

EC MOTORS WITH FREQUENCY CONVERTER

Heat recovery: the recuperator is the counterflow type all-aluminium. On the same is installed a condensate drain basin.

Structure: the frame is made of aluminium and galvanized steel sandwich sound proof panels. The units are equipped with removable panels for access to the interior and make routine and extraordinary maintenance.

Fans: plug fan with EC Brushless engine (models BRUCEC700, BRUCEC1000) centrifugal double suction with electric motor with external rotor EC Brushless direct driven complete of frequency converter. Modbus interface (models BRUCEC2000, BRUCEC3500, BRUCEC4500).

Filters: the units are equipped with standard filter cells wavy synthetic fiber efficiency G4, galvanized steel frame and safety nets in electro galvanized steel wire.



	BRUCEC700	BRUCEC1000	BRUCEC2000	BRUCEC3500	BRUCEC4500
Portata aria (mc/h) Nominal air flow (mc/h)	700	1000	2000	3500	4500
Pressione statica utile (pa) Useful static pressure (pa)	110	190	390	240	350

VENTILATORE DIRETTAMENTE ACCOPPIATO (dati per singolo ventilatore) | FANS (data for each fan)

Potenza nominale (w) Installed power (W)	113	207	1050	1050	2000
I nominale (A) Current (A)	0,8	1,4	4,51	4,53	9,52
Tensione (V) Rated voltage (V)	230	230	230	230	230
Frequenza (Hz) Frequency (HZ)	50	50	50	50	50
Velocità (nr) Speeds (nr)	1	1	1	1	1

FILTRI | FILTERS

Acrilici ondulati efficienza
Corrugated acrylic efficiency

G4 ISO COARSE > 65 %

Con temperature esterne < -3°C necessario preriscaldamento | With fresh air temperature < -3°C it is necessary pre-heating.

DATI ECODESIGN | ECODESIGN DATA SHEET

Modello Model	Efficienza Efficiency	Portata aria nominale Nominal air flow	Pressione statica utile Useful static pressure	SFPInt	SFP-2018	Velocità Frontale Front Speed	Efficienza ventilatore Fan efficiency	Leakage interno Internal leakage	Leakage esterno External leakage
	%	mc/h	pa	w/m ³ /s	w/m ³ /s	m/s	%	%	%
BRUCEC700	79,3	700	110	832	1439	1,24	42	6,6	3,9
BRUCEC1000	81,6	1000	190	946	1496	1,56	44	7,3	5,5
BRUCEC2000	80,7	2000	390	1303,2	1526,4	1,69	51	7,3	5,5
BRUCEC3500	81,7	3500	240	1202,4	1497,6	2,75	55	6,8	4,6
BRUCEC4500	81,3	4500	350	1432,8	1440,0	2,85	56	5,9	4,1

**LIVELLO LW DI POTENZA SONORA IRRAGGIATO DAL CASING
SOUND POWER LW RADIATED FROM THE CASING SHEET**

Dati misurati alla massima velocità | Data measured at maximum speed
Frequenza | Frequency (Hz)

	125	250	500	1000	2000	4000	8000	LwdB(A)
BRUCEC700	60,7	63,4	57,2	54,4	43,9	40,1	41,6	58,7
BRUCEC1000	63	65,2	59,4	56,3	46,6	41,3	43,8	61,6
BRUCEC2000	64,3	73,3	65,2	57,9	50,1	43,3	41,2	67
BRUCEC3500	73,4	76,2	68,4	59	53,4	44,6	44,4	70,3
BRUCEC4500	74,2	78,7	70,5	62,3	55,3	46,4	47,1	71,6

**LIVELLO LW DI POTENZA SONORA IRRAGGIATO DAL VENTILATORE
SOUND POWER LW RADIATED FROM THE FAN**

Dati misurati alla massima velocità | Data measured at maximum speed
Frequenza | Frequency (Hz)

	125	250	500	1000	2000	4000	8000	LwdB(A)
BRUCEC700	61,9	69,5	62,4	57,2	56,7	52,9	63,2	67,3
BRUCEC1000	64,2	73	66,7	60,6	61,9	56,4	65,3	70,6
BRUCEC2000	72,4	83,2	77,1	77,4	72,2	67,1	75,2	80,3
BRUCEC3500	74,2	78	78,4	76,6	73,1	71,4	74,6	79,2
BRUCEC4500	75,3	81,5	80,2	78,2	74,5	72,9	76,4	78,2

INSTALLAZIONE ORIZZONTALE | HORIZONTAL INSTALLATION

PESO | WEIGHT: 135 kg

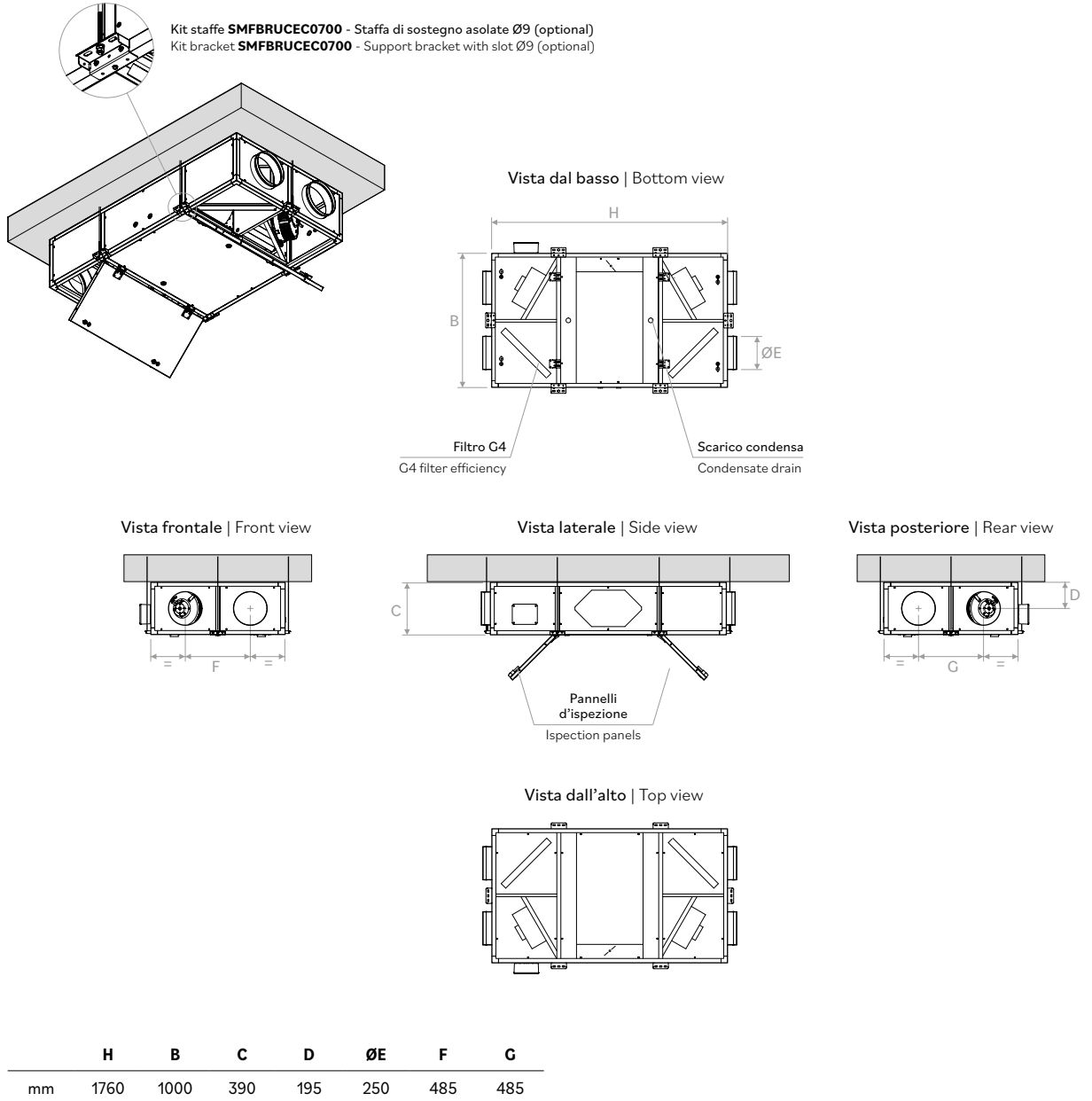

DIAGRAMMI PRESTAZIONALI | PERFORMANCE CHARTS

Pressione statica utile
 Useful static pressure

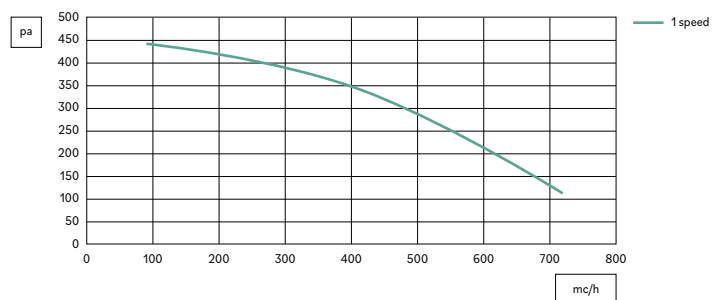

INSTALLAZIONE VERTICALE | VERTICAL INSTALLATION

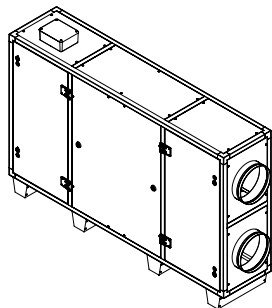

Vista laterale destra
Right side view

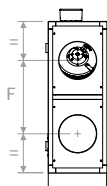

Lato ispezione
Inspection side

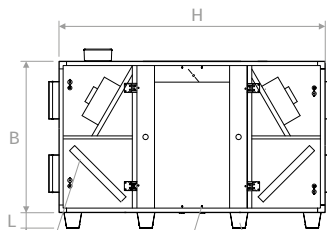

Vista laterale sinistra
Left side view

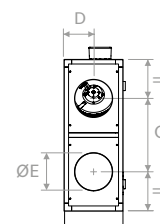

Filtro G4
G4 filter efficiency

Scarico condensa
Condensate drain

Kit punti di appoggio **MSPBRUCEC0700**
Kit support points **MSPBRUCEC0700**

Vista superiore | Upper view

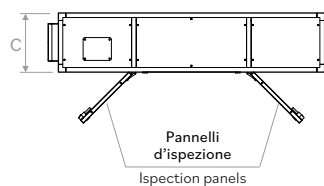

	H	B	C	D	ØE	F	G	L
mm	1760	1000	390	175	250	485	485	100

DIAGRAMMI PRESTAZIONALI | PERFORMANCE CHARTS

SCAMBIATORE CERTIFICATO EN 308 | HEAT EXCHANGER EN 308 CERTIFIED

Diagramma efficienza estiva

Aria esterna: 32 °C / 50 % U.R.
Aria ambiente: 26 °C / 50 % U.R.

Summer efficiency chart

Fresh air: 32 °C / 50 % R.H.
Return air: 26 °C / 50 % R.H.



Diagramma efficienza invernale

Aria esterna: - 5 °C / 80 % U.R.
Aria ambiente: 20 °C / 50 % U.R.

Winter efficiency chart

Fresh air: - 5 °C / 80 % R.H.
Return air: 20 °C / 50 % R.H.

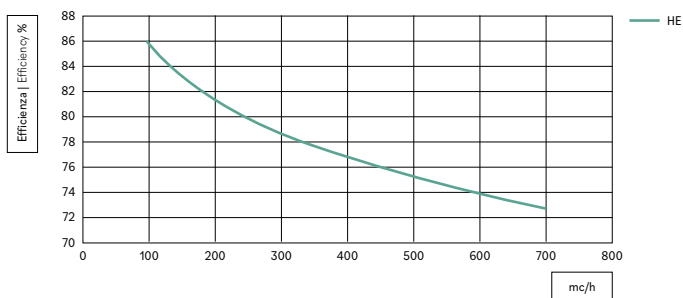
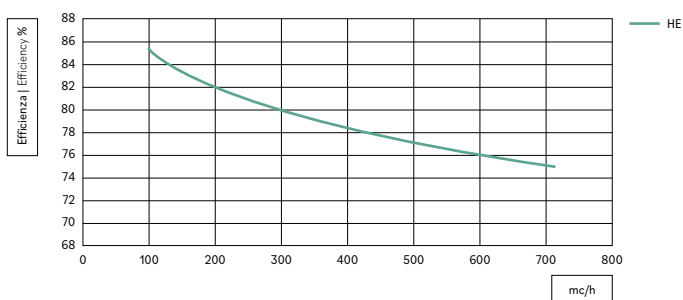

INSTALLAZIONE ORIZZONTALE | HORIZONTAL INSTALLATION

PESO | WEIGHT: 150 kg

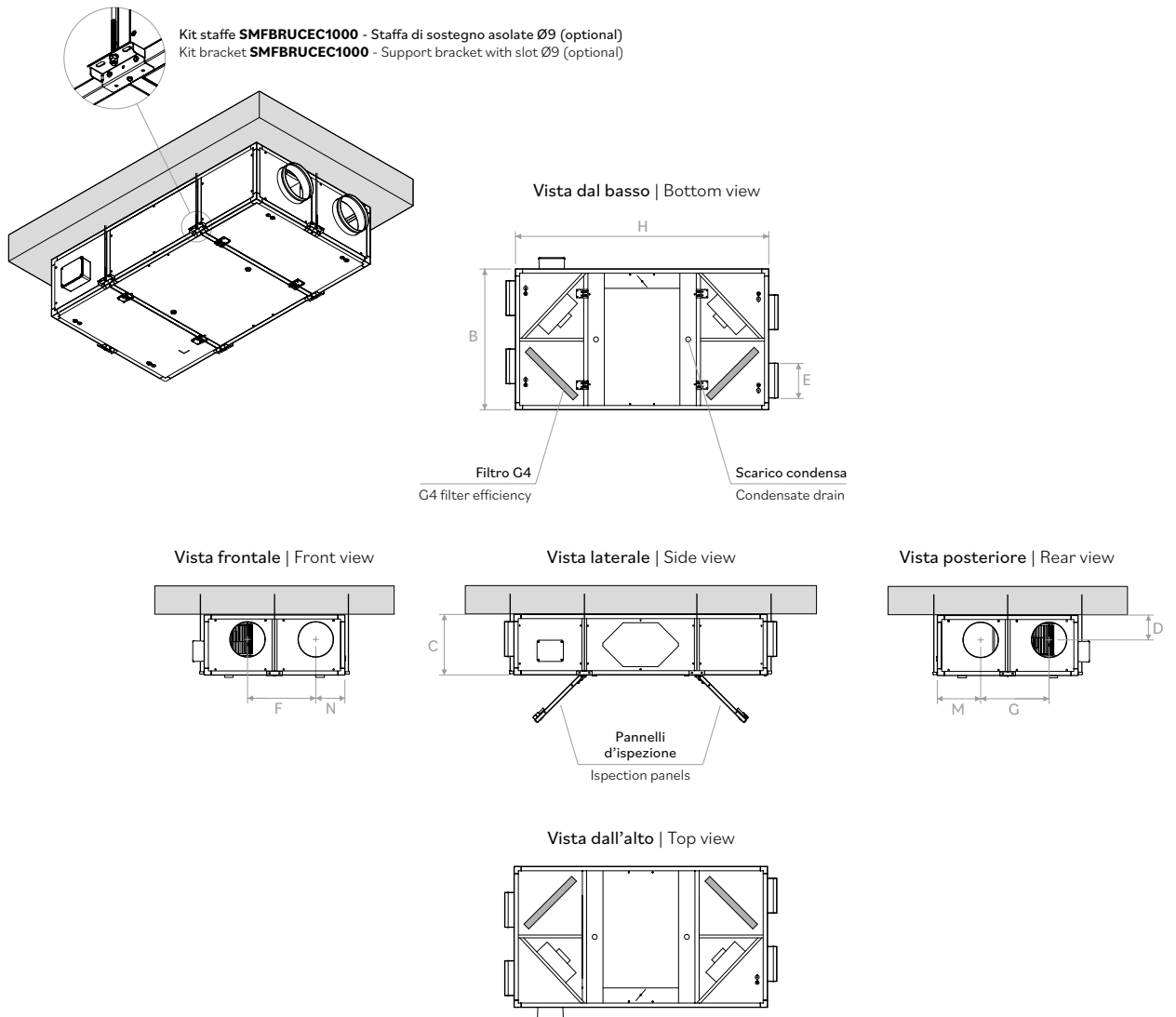

	H	B	C	D	ØE	F	G	M	N
mm	1800	1000	430	175	250	485	485	308	207

DIAGRAMMI PRESTAZIONALI | PERFORMANCE CHARTS

Pressione statica utile
Useful static pressure

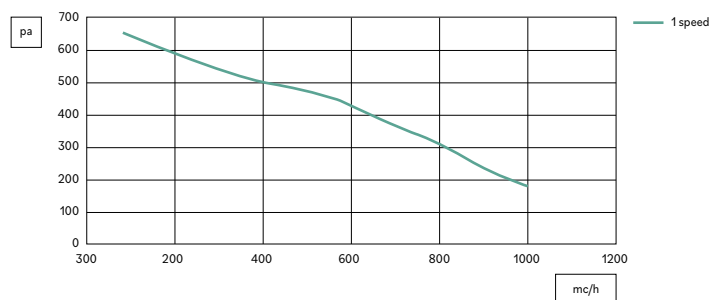

INSTALLAZIONE VERTICALE | VERTICAL INSTALLATION

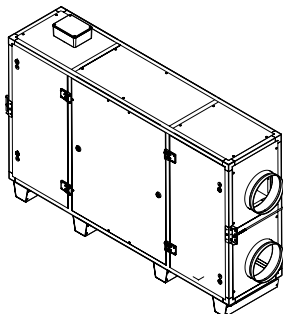

Vista laterale destra
Right side view

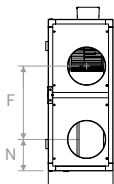

Lato ispezione
Inspection side

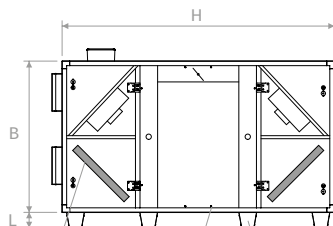

Vista laterale sinistra
Left side view

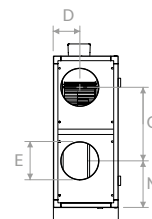

Filtro G4
G4 filter efficiency

Kit punti di appoggio **MSPBRUCEC1000**
Kit support points **MSPBRUCEC1000**

Vista superiore | Upper view

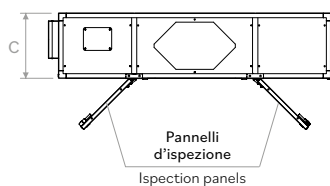

	H	B	C	D	ØE	F	G	L	M	N
mm	1800	1000	430	175	250	485	485	100	308	207

DIAGRAMMI PRESTAZIONALI | PERFORMANCE CHARTS

SCAMBIATORE CERTIFICATO EN 308 | HEAT EXCHANGER EN 308 CERTIFIED

Diagramma efficienza estiva

Aria esterna: 32 °C / 50 % U.R.

Aria ambiente: 26 °C / 50 % U.R.

Summer efficiency chart

Fresh air: 32 °C / 50 % R.H.

Return air: 26 °C / 50 % R.H.



Diagramma efficienza invernale

Aria esterna: - 5 °C / 80 % U.R.

Aria ambiente: 20 °C / 50 % U.R.

Winter efficiency chart

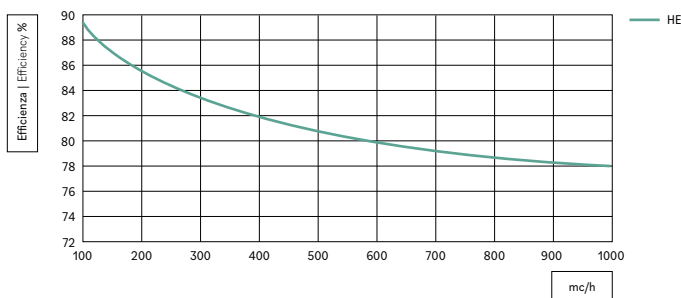
Fresh air: -5 °C / 80 % R.H.

Return air: 20 °C / 50 % R.H.

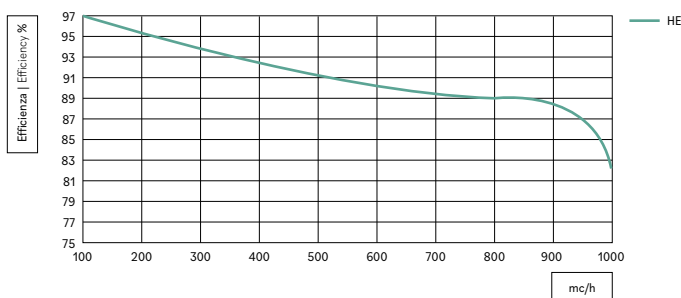

INSTALLAZIONE ORIZZONTALE | HORIZONTAL INSTALLATION

PESO | WEIGHT: 215 kg

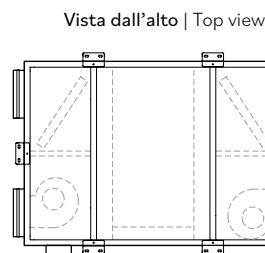
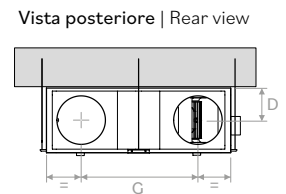
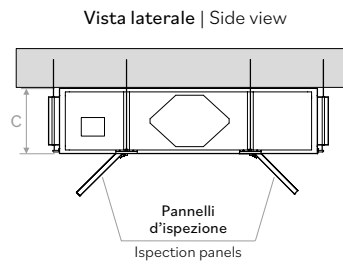
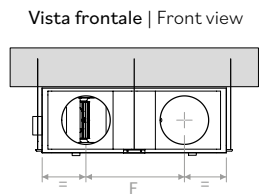
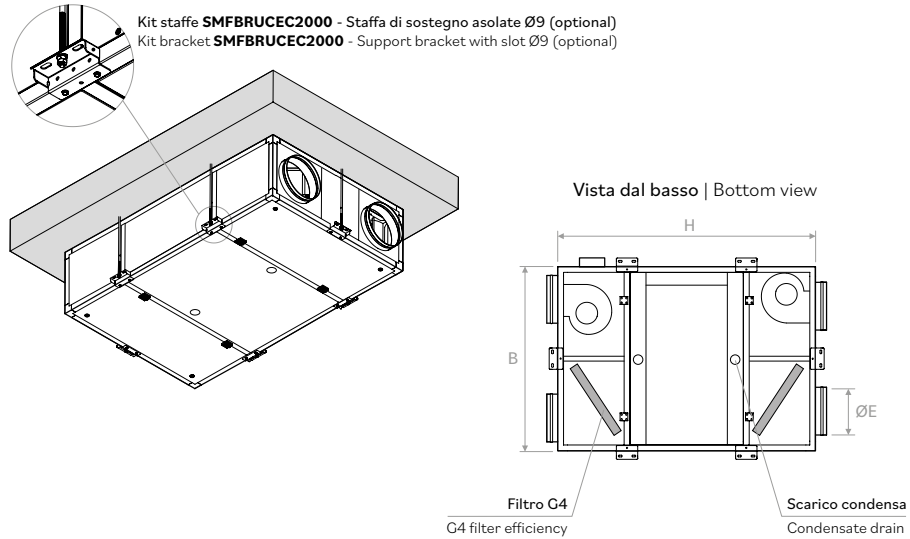

	H	B	C	D	ØE	F	G
mm	2000	1100	510	255	355	498	622

DIAGRAMMI PRESTAZIONALI | PERFORMANCE CHARTS

Pressione statica utile
Useful static pressure

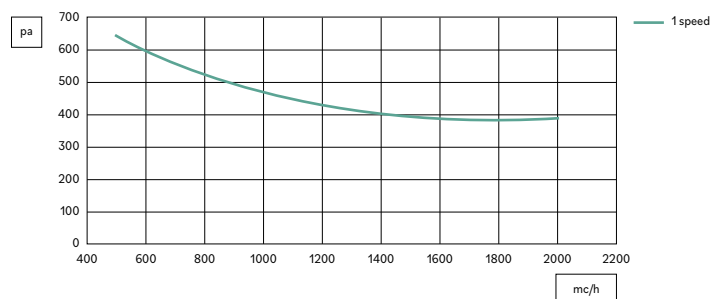

INSTALLAZIONE VERTICALE | VERTICAL INSTALLATION

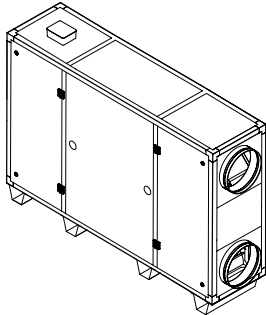

Vista laterale destra
Right side view

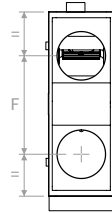

Lato ispezione
Inspection side

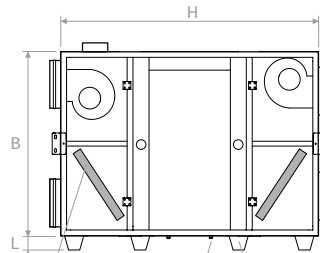

Vista laterale sinistra
Left side view

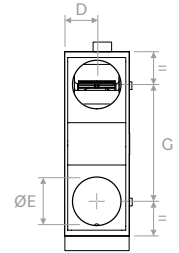

Filtro G4 Scarico condensa Kit punti di appoggio MSPBRUCEC2000
G4 filter efficiency Condensate drain Kit support points MSPBRUCEC2000

Vista superiore | Upper view

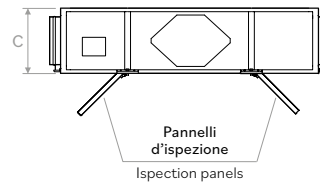

	H	B	C	D	ØE	F	G	L
mm	2000	1100	510	255	355	498	622	100

DIAGRAMMI PRESTAZIONALI | PERFORMANCE CHARTS

SCAMBIATORE CERTIFICATO EN 308 | HEAT EXCHANGER EN 308 CERTIFIED

Diagramma efficienza estiva

Aria esterna: 32 °C / 50 % U.R.

Aria ambiente: 26 °C / 50 % U.R.

Summer efficiency chart

Fresh air: 32 °C / 50 % R.H.

Return air: 26 °C / 50 % R.H.



Diagramma efficienza invernale

Aria esterna: - 5 °C / 80 % U.R.

Aria ambiente: 20 °C / 50 % U.R.

Winter efficiency chart

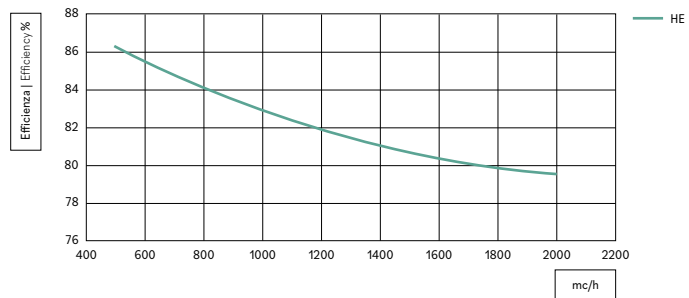
Fresh air: - 5 °C / 80 % R.H.

Return air: 20 °C / 50 % R.H.

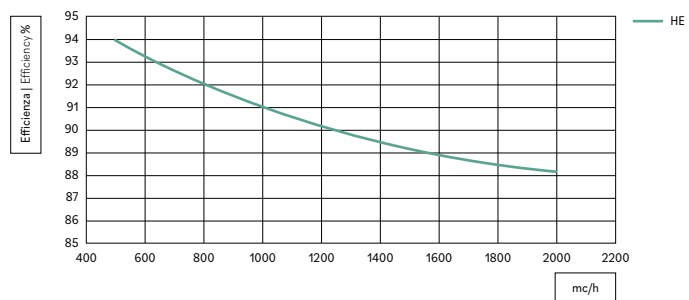

INSTALLAZIONE ORIZZONTALE | HORIZONTAL INSTALLATION

PESO | WEIGHT: 360 kg

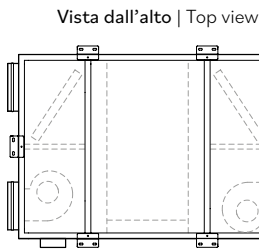
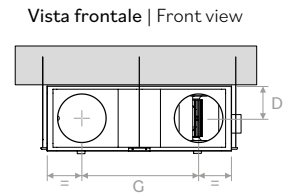
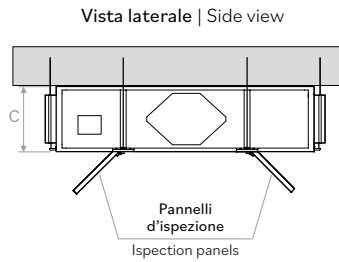
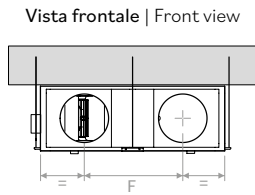
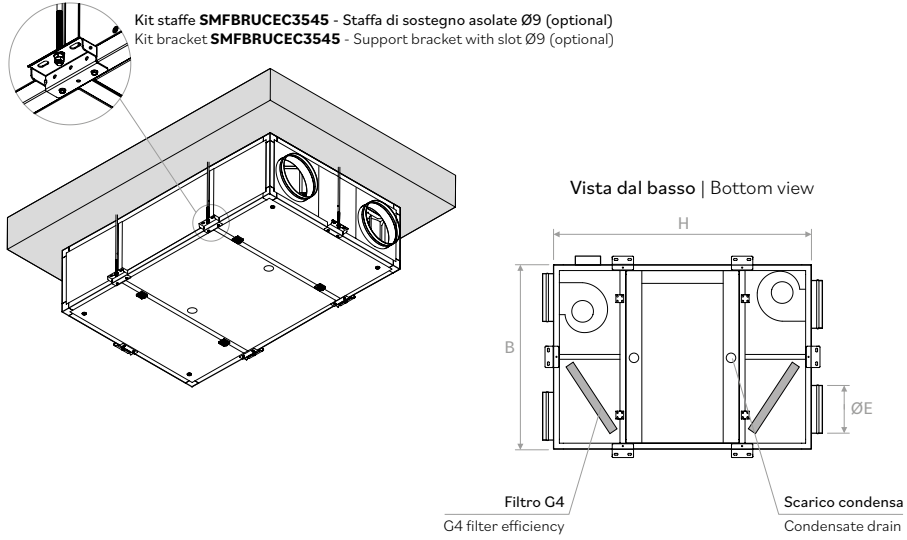

	H	B	C	D	ØE	F	G
mm	2250	1400	650	365	355	860	860

DIAGRAMMI PRESTAZIONALI | PERFORMANCE CHARTS

Pressione statica utile
Useful static pressure

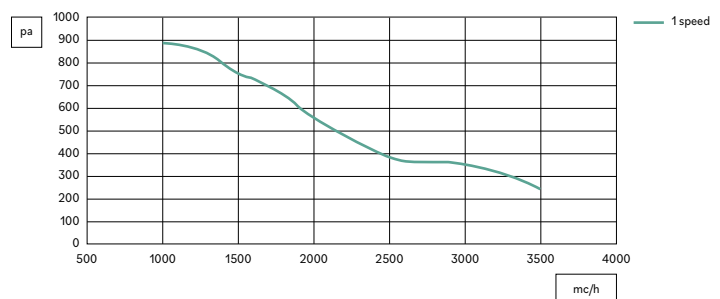

INSTALLAZIONE VERTICALE | VERTICAL INSTALLATION

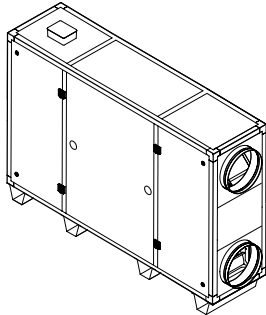

Vista laterale destra
Right side view

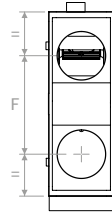

Lato ispezione
Inspection side

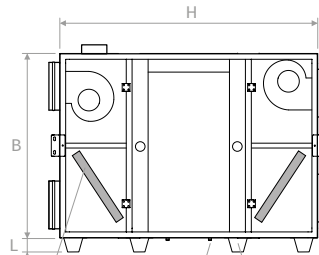

Vista laterale sinistra
Left side view

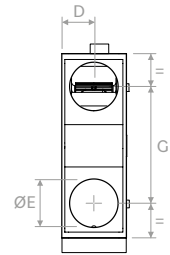

Filtro G4 Scarico condensa Kit punti di appoggio **MSPBRUCEC3545**
G4 filter efficiency Condensate drain Kit support points **MSPBRUCEC3545**

Vista superiore | Upper view

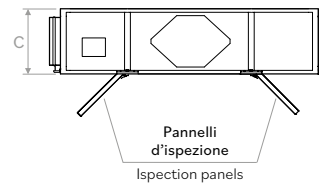

	H	B	C	D	ØE	F	G	L
mm	2250	1400	650	365	355	860	860	100

DIAGRAMMI PRESTAZIONALI | PERFORMANCE CHARTS

SCAMBIATORE CERTIFICATO EN 308 | HEAT EXCHANGER EN 308 CERTIFIED

Diagramma efficienza estiva

Aria esterna: 32 °C / 50 % U.R.

Aria ambiente: 26 °C / 50 % U.R.

Summer efficiency chart

Fresh air: 32 °C / 50 % R.H.

Return air: 26 °C / 50 % R.H.



Diagramma efficienza invernale

Aria esterna: - 5 °C / 80 % U.R.

Aria ambiente: 20 °C / 50 % U.R.

Winter efficiency chart

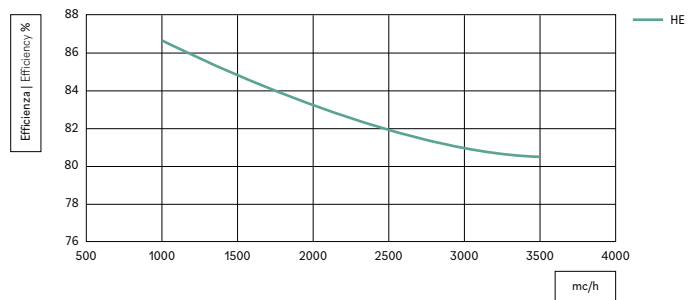
Fresh air: - 5 °C / 80 % R.H.

Return air: 20 °C / 50 % R.H.

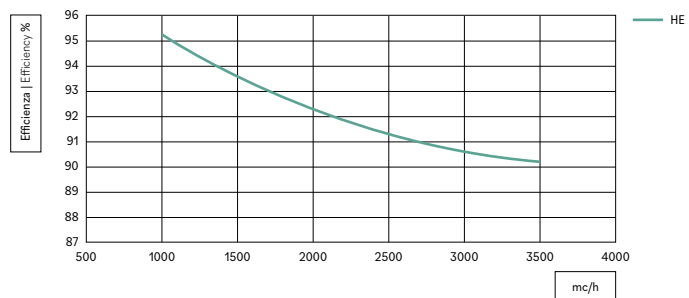

INSTALLAZIONE ORIZZONTALE | HORIZONTAL INSTALLATION

PESO | WEIGHT: 400 kg

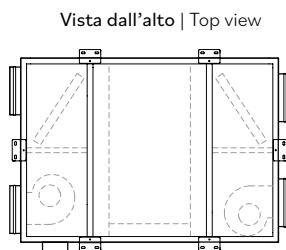
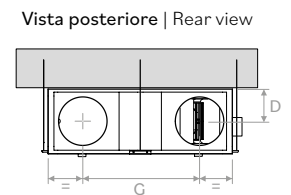
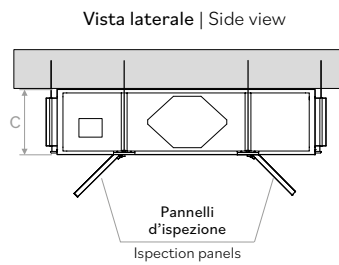
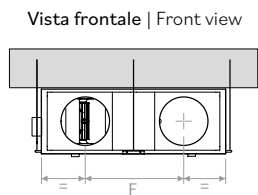
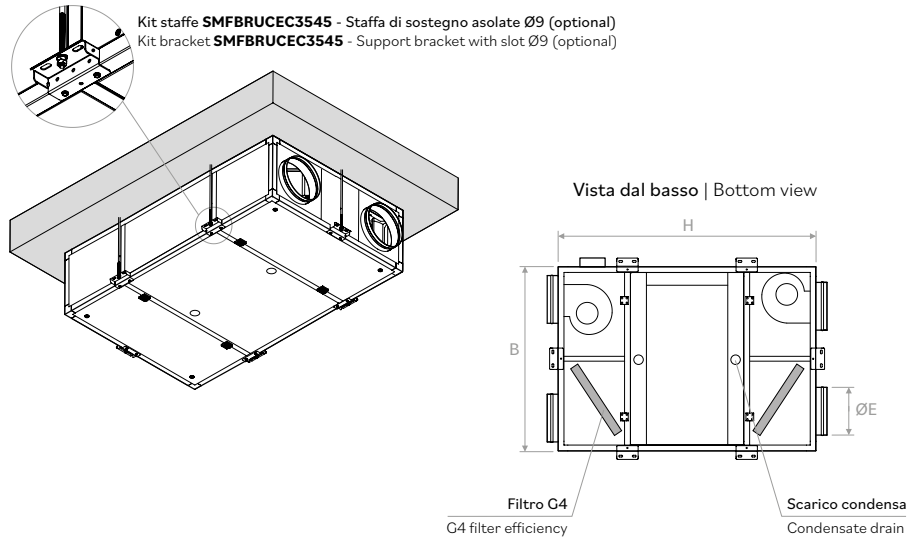

	H	B	C	D	ØE	F	G
mm	2500	1650	650	365	400	985	985

DIAGRAMMI PRESTAZIONALI | PERFORMANCE CHARTS

Pressione statica utile
Useful static pressure

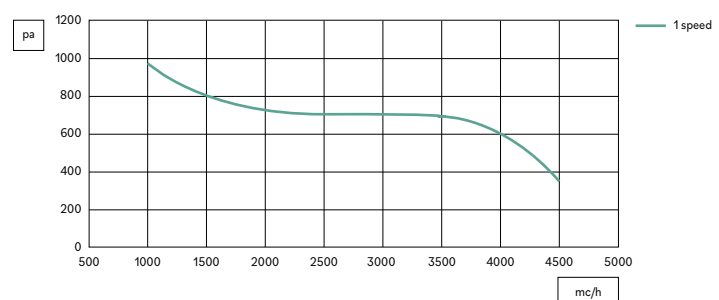

INSTALLAZIONE VERTICALE | VERTICAL INSTALLATION

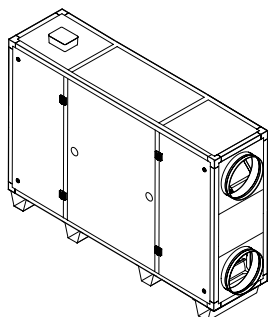

Vista laterale destra
Right side view

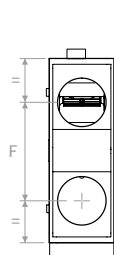

Lato ispezione
Inspection side

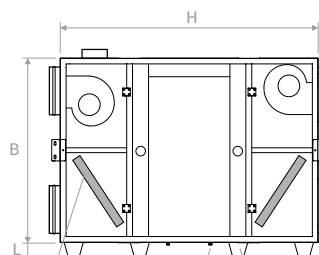

Vista laterale sinistra
Left side view

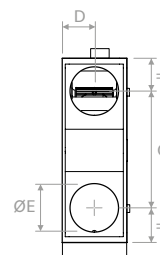

Filtro G4 Scarico condensa Kit punti di appoggio **MSPBRUCEC3545**
G4 filter efficiency Condensate drain Kit support points **MSPBRUCEC3545**

Vista superiore | Upper view

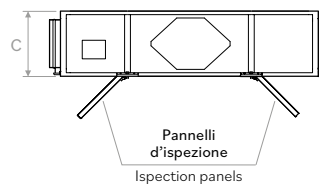

	H	B	C	D	ØE	F	G	L
mm	2500	1650	650	365	400	985	985	100

DIAGRAMMI PRESTAZIONALI | PERFORMANCE CHARTS

SCAMBIATORE CERTIFICATO EN 308 | HEAT EXCHANGER EN 308 CERTIFIED

Diagramma efficienza estiva

Aria esterna: 32 °C / 50 % U.R.

Aria ambiente: 26 °C / 50 % U.R.

Summer efficiency chart

Fresh air: 32 °C / 50 % R.H.

Return air: 26 °C / 50 % R.H.



Diagramma efficienza invernale

Aria esterna: - 5 °C / 80 % U.R.

Aria ambiente: 20 °C / 50 % U.R.

Winter efficiency chart

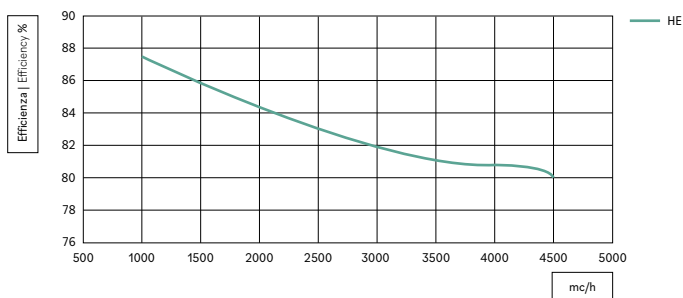
Fresh air: - 5 °C / 80 % R.H.

Return air: 20 °C / 50 % R.H.

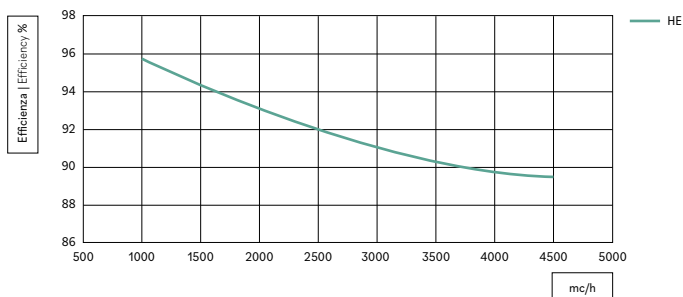

ORIENTAMENTO VERSIONE ORIZZONTALE (vista superiore) | CONFIGURATIONS HORIZONTAL VERSION (top view)

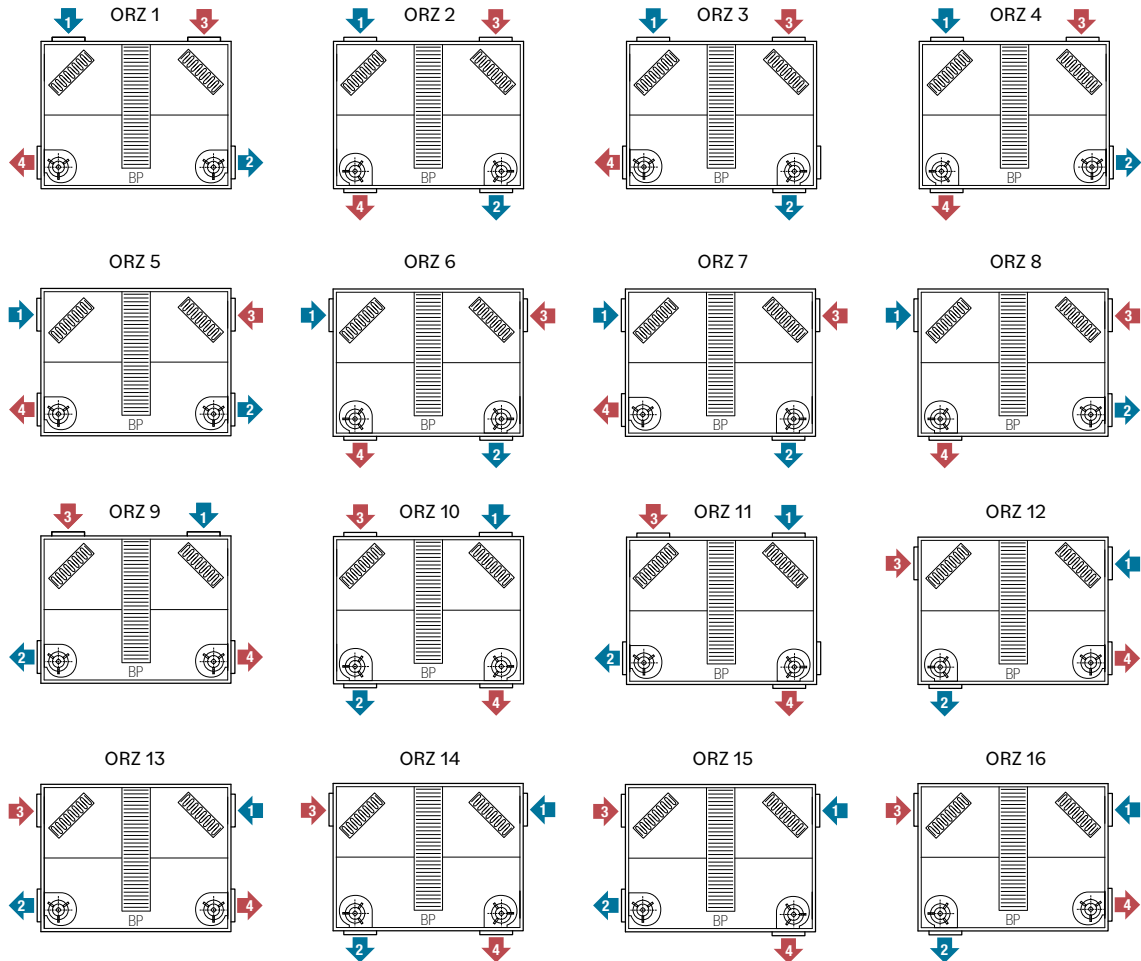

ORIENTAMENTO VERSIONE VERTICALE (vista frontale lato ispezione) | CONFIGURATIONS VERTICAL VERSION (front view inspection side)

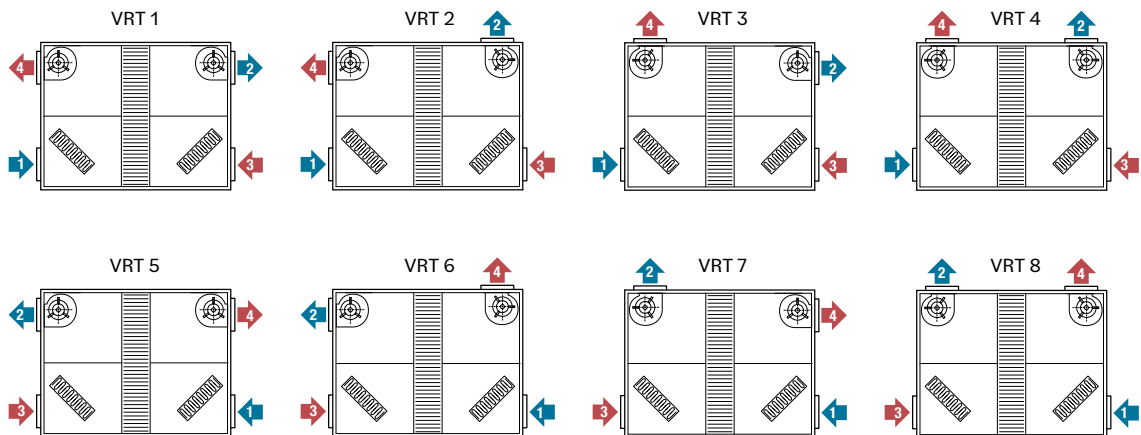

- Leggenda | Legend**
- 1 = aria esterna | fresh air
 - 2 = mandata | supply
 - 3 = ripresa | return
 - 4 = espulsione | exhaust air



CODICI | CODES

Modello | Model

BRUCEC700**BRUCEC1000****BRUCEC2000****BRUCEC3500****BRUCEC4500**

Versione da esterno BRUCECOE e BRUCECVE prezzi a richiesta
Outdoor version BRUCECOE and BRUCECVE prices on request

ACCESSORI | ACCESSORIES

Modello | Model

REP

Regolatore velocità | Speed control
Consigliati 2 regolatori di velocità per unità | Recommended 2 speed controls for unit

SMFBRUCEC0700
SMFBRUCEC1000
SMFBRUCEC2000
SMFBRUCEC3545

Kit staffe per installazione a soffitto | Kit brackets for ceiling mounting

MSPBRUCEC0700
MSPBRUCEC1000
MSPBRUCEC2000
MSPBRUCEC3545

Kit punti di appoggio per installazione verticale | Kit support points for vertical installation

GRUPPO POST TRATTAMENTO ESTIVO | SUMMER COOLING GROUP

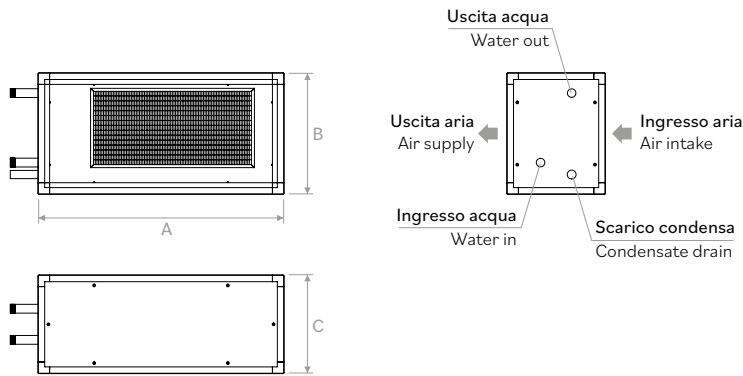

Aria ingresso: 29,5°C - 65% U.R. / Acqua ingresso: 7°C / Acqua uscita: 12°C
 Air inlet: 29,5°C - 65% U.R. / Water in: 7°C / Water out: 12°C

Dimensioni | Dimensions

Modello Model	Temperatura aria uscita Exit air temperature	U.R. aria uscita Exit air relative humidity	Potenzialità Capacity	Portata acqua Water flow	Perdita carico lato aria Air pressure drop	Perdita carico lato acqua Pressure drop water side	Diametro attacchi Diameter water connections	Base gruppo Base group	Altezza gruppo Height group	Spessore gruppo Thickness group
	°C	%	Kw	mc/h	pa	kpa	pollici inches	A mm	B mm	C mm
BAFRECE1000*	16	96	9,21	1,6	73	12,3	3/4	750	370	300
BAFRECE2000	16	93	18,9	3,2	68	26,6	3/4	1100	430	300
BAFRECE3500	16	93	33,1	5,7	62	18,9	1	1400	610	300
BAFRECE4500	19,2	86	32,5	5,6	83	28,3	1	1600	610	300

BATTERIA POST-RISCALDAMENTO ALTA TEMPERATURA | POST- HEATING HIGH TEMPERATURE COIL

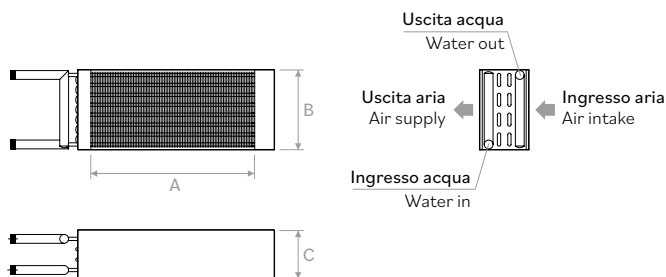

Aria ingresso: 8°C / Acqua ingresso: 70°C / Acqua uscita: 60°C
 Air inlet: 8°C / Water in: 70°C / Water out: 60°C

Dimensioni | Dimensions

Modello Model	Temperatura aria uscita Exit air temperature	Potenzialità Capacity	Portata acqua Water flow	Perdita carico lato aria Air pressure drop	Perdita carico lato acqua Pressure drop water side	Diametro attacchi Diameter water connections	Base passaggio aria Base air passage	Altezza passaggio aria Height air passage	Spessore Thickness air passage
	°C	Kw	mc/h	pa	kpa	pollici inches	A mm	B mm	C mm
BRATREC1000*	25	8,89	0,8	22	12,8	1/2	500	300	90
BRATREC2000	25	11,8	1	26	23,6	1/2	600	300	90
BRATREC3500	25	20,7	1,8	20	16,7	3/4	800	480	100
BRATREC4500	25	26,6	2,3	27	8	1	1000	480	120

* Adatto per BRUCEC1000 e BRUCEC700 | Suitable for BRUCEC1000 and BRUCEC700



BATTERIA POST-RISCALDAMENTO BASSA TEMPERATURA | POST-HEATING LOW TEMPERATURE COIL

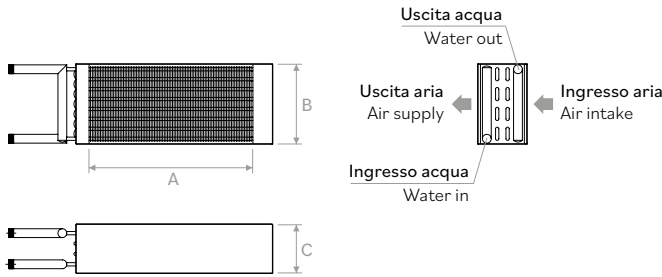

Aria ingresso: 8°C / Acqua ingresso: 45°C / Acqua uscita: 40°C
 Air inlet: 8°C / Water in: 45°C / Water out: 40°C

Dimensioni | Dimensions

Modello Model	Temperatura aria uscita Exit air temperature	Potenzialità Capacity	Portata acqua Water flow	Perdita carico lato aria Air pressure drop	Perdita carico lato acqua Pressure drop water side	Diametro attacchi Diameter water connection	Base passaggio aria Base air passage	Altezza passaggio aria Height air passage	Spessore Thickness air passage
	°C	Kw	mc/h	pa	kpa	pollici inches	A mm	B mm	C mm
BRBTREC1000*	30	26,8	4,7	28	15,1	1	1000	480	160
BRBTREC2000	30	15,3	2,7	31	12,6	3/4	850	300	150
BRBTREC3500	30	26,8	4,7	28	15,1	1	1000	480	160
BRBTREC4500	30	34,4	6	37	10	1½	1300	480	170

BATTERIA ELETTRICA TRIFASE | ELECTRICAL COIL 400 VOLT

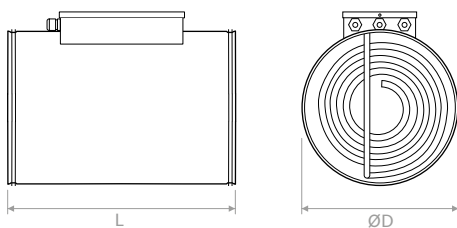

Aria ingresso: 8°C / Alimentazione: 400 Volt - 50 Hz
 Air inlet: 8°C / Electrical data: 400 Volt - 50 Hz

Dimensioni | Dimensions

Modello Model	Temperatura aria uscita Exit air temperature	Potenzialità Capacity	Stadi Levels	Ø D Diametro Diameter	L Lunghezza Length
	°C	Kw	NR.	mm	mm
BETREC1000*	20	4,5	3	250	370
BETREC1500	20	6,6	3	355	373
BETREC2500	20	10,5	3	355	373
BETREC3500	20	15	3	400	630

* Adatto per BRUCEC1000 e BRUCEC700 | Suitable for BRUCEC1000 and BRUCEC700

BRUCEC

BATTERIA ELETTRICA MONOFASE | ELECTRICAL COIL 230 VOLT

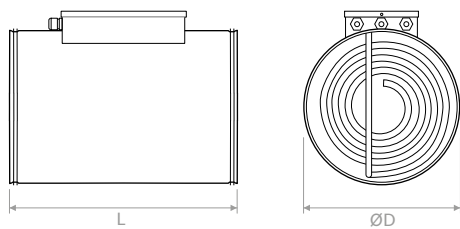

Aria ingresso: 8°C / Alimentazione: 230 Volt - 50 Hz
Air inlet: 8°C / Electrical data: 230 Volt - 50 Hz

Dimensioni | Dimensions

Modello Model	Temperatura aria uscita Exit air temperature	Potenzialità Capacity	Stadi Levels	Ø D Diametro Diameter	L Lunghezza Lenght
	°C	Kw	NR.	mm	mm
BEMREC1000*	20	4,2	3	250	370
BEMREC1500	20	6,3	3	355	373
BEMREC2500	20	10,6	3	355	373
BEMREC3500	20	15	3	400	630

BATTERIA ELETTRICA TRIFASE AUTOREGOLANTE ELECTRICAL COIL 400 VOLT SELF-REGULATING

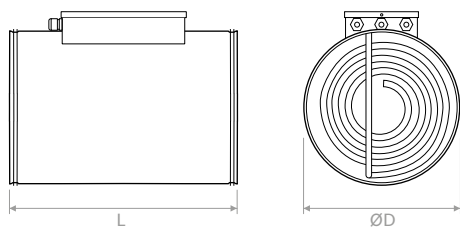

Aria ingresso: 8°C / Alimentazione: 400 Volt - 50 Hz
Air inlet: 8°C / Electrical data: 400 Volt - 50 Hz

Dimensioni | Dimensions

Modello Model	Potenzialità Capacity	Ø D Diametro Diameter	L Lunghezza Lenght
	Kw	mm	mm
BETREC025006000AR	6	250	370
BETREC035509000AR	9	355	373
BETREC035512000AR	12	355	373
BETREC035515000AR	15	355	373
BETREC035518000AR	18	355	373
BETREC040024000AR	24	400	630

Adatte solo per funzionamento come batterie di pre-riscaldamento
Suitable only for pre-heating battery operating

* Adatto per BRUCEC1000 e BRUCEC700 | Suitable for BRUCEC1000 and BRUCEC700

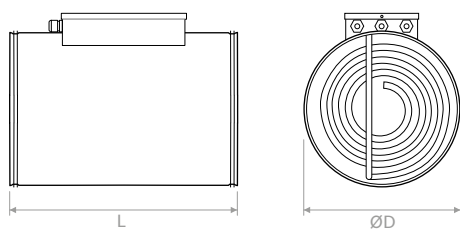

**BATTERIA ELETTRICA MONOFASE AUTOREGOLANTE
ELECTRICAL COIL 230 VOLT SELF-REGULATING**

Aria ingresso: 8°C / Alimentazione: 230 Volt - 50 Hz
Air inlet: 8°C / Electrical data: 230 Volt - 50 Hz

Dimensioni | Dimensions

Modello Model	Potenzialità Capacity Kw	Ø D Diametro Diameter mm	L Lunghezza Length mm
BEMREC025004200AR	4,2	250	370
BEMREC025006000AR	6	250	370

Adatte solo per funzionamento come batterie di pre-riscaldamento
Suitable only for pre-heating battery operating

ALTA EFFICIENZA FILTRI | HIGH EFFICIENCY FILTERS

Modello Model	Efficienza Efficiency
GFTBRUC0700	F7 ISO e PM1 > 65 % adatto per - suitable for BRUCEC700
GFTBRUC1000	F7 ISO e PM1 > 65 % adatto per - suitable for BRUCEC1000
GFTBRUC1500	F7 ISO e PM1 > 65 % adatto per - suitable for BRUCEC2000
GFTBRUC2500	F7 ISO e PM1 > 65 % adatto per - suitable for BRUCEC3500
GFTBRUC3500	F7 ISO e PM1 > 65 % adatto per - suitable for BRUCEC4500

Installabili nell'unità al posto dei filtri G4 di serie. Prezzo al pezzo
Installable in side the unit instead of G4 series filters. Price for pieces

SET FILTRI G4 | G4 SET FILTER

Modello Model	Efficienza Efficiency
FABRUCEC0700	G4 ISO COARSE > 65 %
FABRUCEC1000	G4 ISO COARSE > 65 %
FABRUCEC2000	G4 ISO COARSE > 65 %
FABRUCEC3500	G4 ISO COARSE > 65 %
FABRUCEC4500	G4 ISO COARSE > 65 %

Prezzo per set di 2 filtri | Price for set of 2 filters

SISTEMA DI REGOLAZIONE (funzioni di regolazione) | CONTROL SYSTEM (control functions)

	CTRBASIC BRUCEC	CTR2 BRUCEC	CTR3 BRUCEC	CTR4 BRUCEC	CTR5 BRUCEC	CTR6 BRUCEC	CTR7 BRUCEC	CTR8 BRUCEC	CTR9 BRUCEC
Gestione automatica by-pass scambiatore Automatic heat exchanger by-pass management	•	•	•	•	•	•	•	•	•
Monitoraggio filtri sporchi con pressostati differenziali Dirty filter monitoring with differential pressure switches	•	•	•	•	•	•	•	•	•
Controllo velocità ventilatori proporzionale Proportional fan speed control	•	•	•	•	•	•	•	•	•
Ingresso STOP incendio da remoto Remote fire STOP unit input	•	•	•	•	•	•	•	•	•
Ingresso ON/OFF unità da remoto Remote unit ON / OFF input	•	•	•	•	•	•	•	•	•
Programmazione giornaliera/settimanale Daily/weekly programming timer	•	•	•	•	•	•	•	•	•
Comunicazione MODBUS RS485 MODBUS RS485 communication	•	•	•	•	•	•	•	•	•
Uscita anomalia generica unità Generic unit failure output		•	•	•	•			•	•
Uscita stato ON/OFF unità Unit ON / OFF status output		•	•	•	•			•	•
Uscita estate / inverno Summer / winter status output			•	•	•			•	•
Regolazione batteria ad acqua (compresa valvola motorizzata) Water coil control (motorized valve included)		•				•	•		
Regolazione batteria elettrica (escluso quadro di potenza). Prezzo quadro elettrico potenza tabella sotto Electric battery control (excluding power electric box). Price power electric box table below			•					•	•
Controllo velocità ventilatori da sonda CO ₂ (compresa) installata a bordo macchina Fan speed control from CO ₂ probe (included) installed on the machine				•		•		•	
Controllo velocità ventilatori da sonda umidità (compresa) Fan speed control from humidity probe (included)					•		•		•



SISTEMA DI REGOLAZIONE (descrizione) | CONTROL SYSTEM (description)

Sistema di regolazione cablato a bordo macchina e testato in fabbrica completo di:

- Quadro elettrico di potenza ed automazione.
- Organi di controllo ed automazione a bordo macchina.
- Terminale operatore remotabile sino a 20 metri.

(Sistema non fornibile dopo consegna unità)



Control system wired on board the machine and tested in the factory complete with:

- Electric power and automation box.
- Control and automation devices on the machine.
- Operator terminal remotable up to 20 meters long.

(System not available after unit delivery)



CODICI | CODES

Modello | Model

CTR BASIC BRUCEC

CTR2 BRUCEC

CTR3 BRUCEC

CTR4 BRUCEC

CTR5 BRUCEC

CTR6 BRUCEC

CTR7 BRUCEC

CTR8 BRUCEC

CTR9 BRUCEC

Altri sistemi di controllo eseguibili su richiesta
Other control systems available on request

QUADRO ELETTRICO POTENZA BATTERIE ELETTRICA | POWER ELECTRIC BOX ELECTRIC BATTERY

Modello Model	Kw
BRUCQE45	4,5
BRUCQE66	6,6
BRUCQE105	10,5
BRUCQE150	15

