

ECOFILTRO PLUS



ILH BERLIN
INSTITUT FÜR LUFTHYGIENE

ACCREDIA
ENTE ITALIANO ACCREDITAMENTO



MODULO DI FILTRAZIONE REMOTATO AD ALTISSIMA EFFICIENZA PER VMC

Caratteristiche: filtro elettronico per unità di recupero calore domestico. Composto da griglia di polarizzazione e piastre captatrici complete di telaio di supporto. Sistema elettronico di generazione e controllo. Plenum di contenimento e raccordo in materiale plastico. Sicurezza assoluta con sgancio in fase di manutenzione. Spazio per inserimento prefiltra opzionale.

HIGH EFFICIENCY FILTRATION MODULE FOR VMC SYSTEMS

Characteristics: electronic filter for domestic heat recovery unit. Consisting of polarizing grille and collection plates complete support frame. Electronic system for generation and control. Containment and fitting plenum of plastic material. Absolute safety with release during maintenance. Space for prefilter installation optional.

DESCRIZIONE PARAMETRI PARAMETER DESCRIPTION	UNITÀ DI MISURA UNIT OF MEASURE	VALORI VALUES
Tensione Rated voltage	V	230
Frequenza Frequency	Hz	50
Potenza nominale Installed power	W	9
Portata aria massima Maximum air flow rate	m ³ /h	420
Massima perdita di carico Maximum air pressure drop	Pa	34
Efficienza UNI 11254 ePM2,5 Efficiency UNI 11254 ePM2,5	%	90/95
Efficienza filtrazione batterica Bacterial filtration efficiency	%	> 90



DISEGNI | DRAWINGS

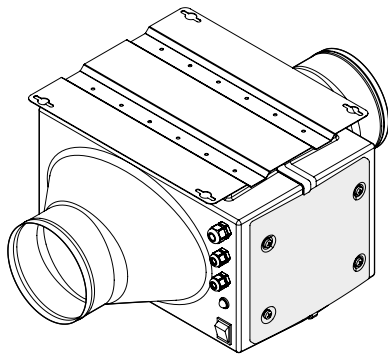

Vista isometrica dal basso
Isometric bottom view

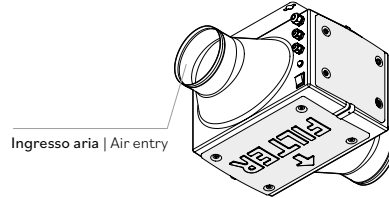

Vista isometrica dall'alto
Isometric top view

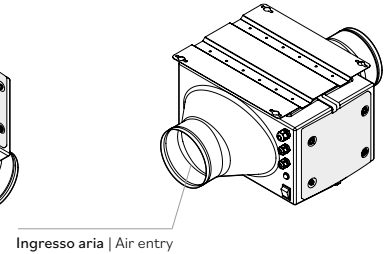

Vista dal basso | Bottom View

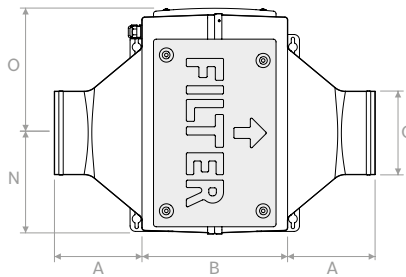

Vista frontale | Front view

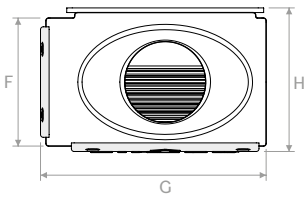

Vista laterale | Side view

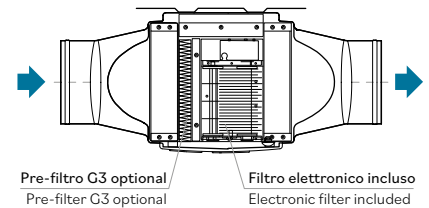
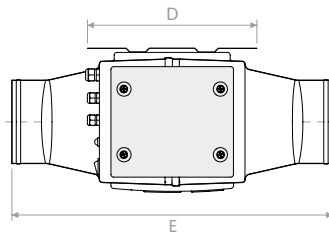

Vista dall'alto | Top view

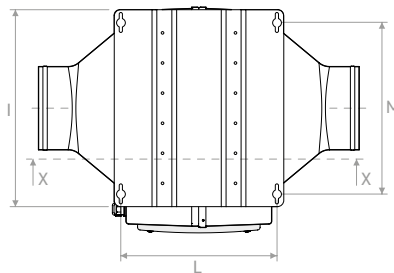

	A	B	C	D	E	F	G	H	I	L	M	N	O
mm	160	266	Ø 156	310	586	234	412	262	360	286	314	185	228

CODICI | CODES

Modello | Model

ECOFILTROPLUS

PF ECOFILTROPLUS*

* Prefiltro efficienza G3 | Prefilter G3 efficiency.