

RDCD25SKCE

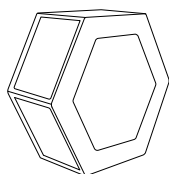

4BRF



Incluso - Scambiatore entalpico
Included - Enthalpic heat exchanger

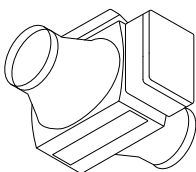

Optional - ECOFILTRU PLUS

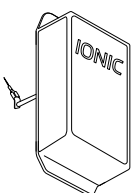

Optional - IONIC

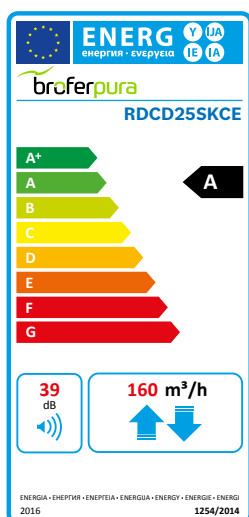

UNITÀ DI RECUPERO CALORE DOMESTICA CENTRALIZZATA AD ALTISSIMA EFFICIENZA REGOLAZIONE PLUG AND PLAY WIRELESS INCLUSA BY-PASS AUTOMATICO INCLUSO INSTALLAZIONE ORIZZONTALE-VERTICALE-DESTRA-SINISTRA

Recuperatore di calore: in controcorrente interamente realizzato in materiale plastico. *Versione con scambiatore entalpico.*

Struttura: autoportante in PPE a tenuta completa di sistema estrazione filtri. Casing esterno in lamiera preverniciata con isolamento fono assorbente.

Ventilatori: plug fan con motore EC Brushless a semplice aspirazione.

Filtri: le unità sono provviste di serie con celle filtranti ondulate in fibra sintetica classe G4, in opzione filtro efficienza F7 su aria esterna.

DOMESTIC CENTRALIZED HEAT RECOVERY UNIT WITH VERY HIGH EFFICIENCY AND WITH WIRELESS PLUG AND PLAY CONTROL SYSTEM INCLUDED AUTOMATIC BY-PASS INCLUDED INSTALLATION HORIZONTAL-VERTICAL-RIGHT -LEFT

Heat recovery: heat exchanger of the type in countercurrent entirely made of plastic material. *Version with enthalpic heat exchanger.*

Structure: free standing EPP seal, complete of filters ex traction system. External casing made by prepainted steel with sound proof insulation.

Fans: plug fan with EC Brushless engine single inlet.

Filters: the units are equipped with standard filter cells synthetic fiber efficiency G4, optional F7 efficiency on fresh air.

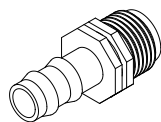

Predisposizione per scarico della condensa.
Predisposition for condensate drying.

Portata aria (mc/h) Nominal air flow (mc/h)	160
Pressione statica utile (pa) Useful static pressure (pa)	100

DATI PER SINGOLO VENTILATORE | DATA FOR EACH FAN

Potenza nominale (W) Installed power (W)	27
Giri (1/min) Round (1/MIN)	3700
I nominale (A) Current (A)	0.27
Tensione (V) Rated voltage (V)	230
Frequenza (Hz) Frequency (HZ)	50
Velocità (nr) Speed (nr)	3+(1 booster)

FILTRI | FILTERS

Efficienza Efficiency Standard	G4 ISO COARSE > 65 %
Efficienza Efficiency Optional	F7 ISO e PM1 > 65 %

DISEGNI | DRAWINGS

PESO | WEIGHT: 30 kg

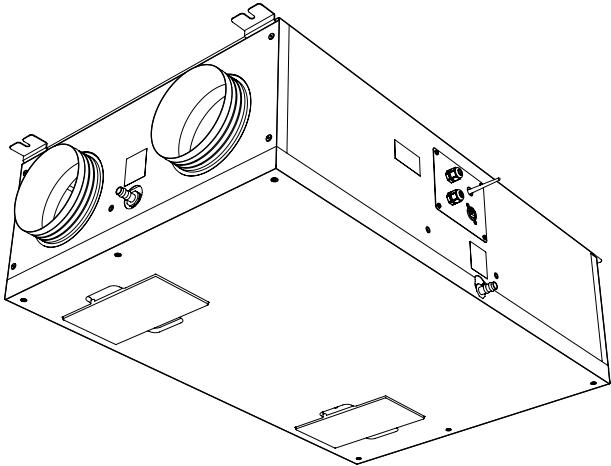

Vista dal basso | Bottom View

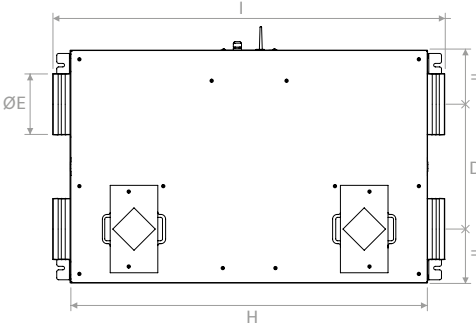

Vista interna | Internal view

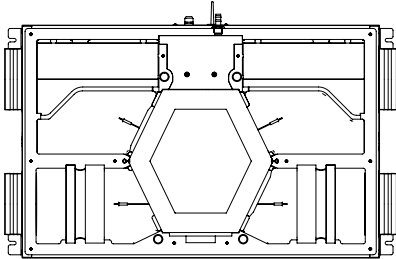

Vista laterale | Side view

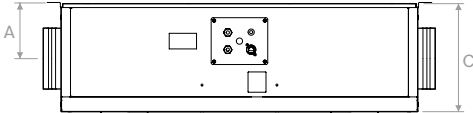

Vista frontale | Front view

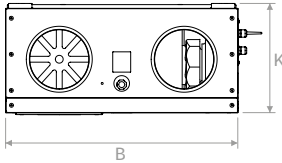

Vista in pianta | Plan view

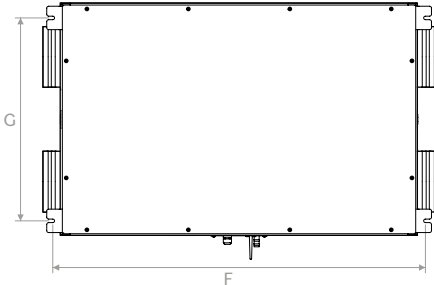

	A	B	C	D	ØE	F	G	H	I	K
mm	135	595	277	320	156	955	520	914	1005	282



DIAGRAMMI PRESTAZIONALI | PERFORMANCE CHARTS

PRESTAZIONI CERTIFICATE EN 13141:7:2011 | PERFORMANCE EN 13141:7:2011 CERTIFIED

Pressione statica utile
Useful static pressure
① ③

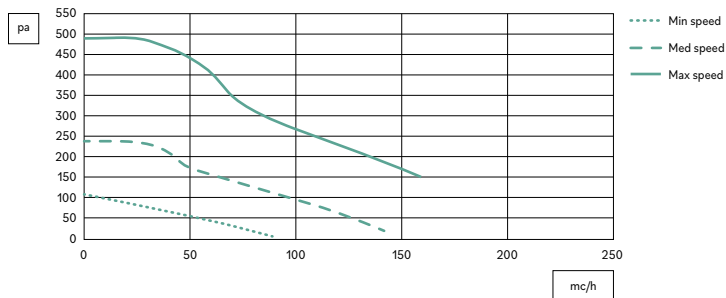

Potenza specifica ventilatore S.F.P.
S.F.P.
②



Diagramma efficienza sensibile invernale
Aria esterna: 25 °C
Aria ambiente: 5 °C
Winter sensible efficiency chart
Fresh air: 25 °C
Return air: 5 °C



Diagramma efficienza latente invernale
Aria esterna: 5 °C - 79 % U.R.
Aria ambiente: 25 °C - 50 % U.R.
Winter latent efficiency chart
Fresh air: 5 °C - 79 % R.H.
Return air: 25 °C - 50 % R.H.

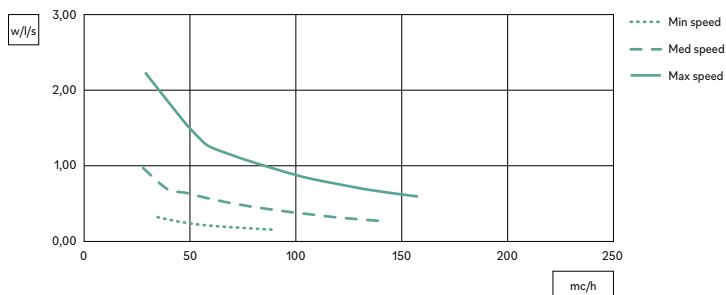

① Dati con filtri G4 standard | Data with standard G4 filters
 ② Dati per singolo ventilatore | Data for single fan
 ③ Perdite di carico filtro efficienza F7 80 pa alla massima portata con filtro pulito
 Air pressure drop with F7 efficiency filter 80 pa at maximum air flow rate with clean filter

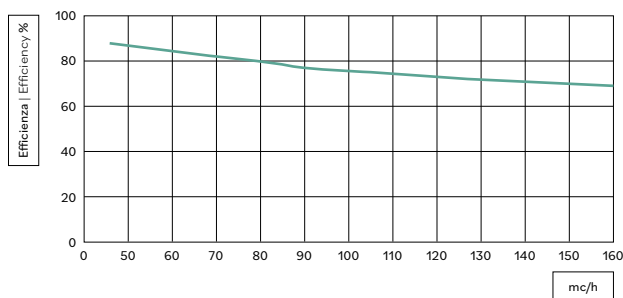
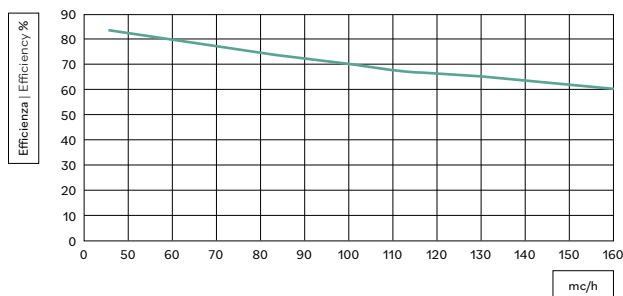

Diagramma efficienza sensibile estiva

Aria esterna: 35 °C
Aria ambiente: 25 °C

Summer sensible efficiency chart

Fresh air: 35 °C
Return air: 25 °C



Diagramma efficienza latente estiva

Aria esterna: 35 °C - 57 % U.R.
Aria ambiente: 25 °C - 50 % U.R.

Summer latent efficiency chart

Fresh air: 35 °C - 57 % R.H.
Return air: 25 °C - 50 % R.H.

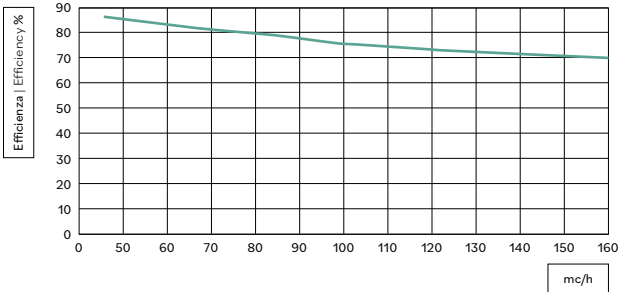
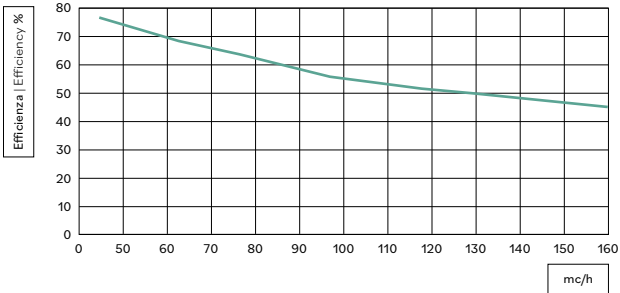

INSTALLAZIONE VERTICALE A PARETE | VERTICAL WALL INSTALLATION

Tipo | Type A (Standard)



Tipo | Type B



INSTALLAZIONE ORIZZONTALE A SOFFITTO | HORIZONTAL CEILING INSTALLATION

Tipo | Type A (Standard)



Tipo | Type A1 (Standard)

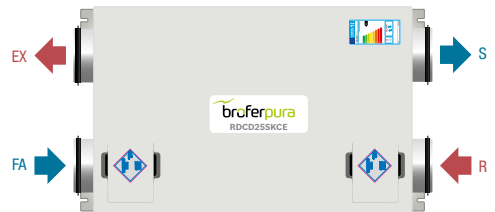

Tipo | Type B

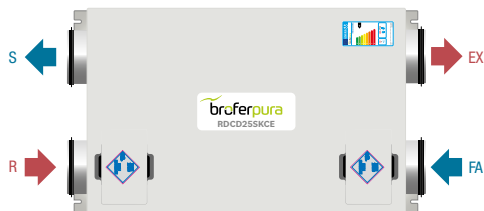

Tipo | Type B1

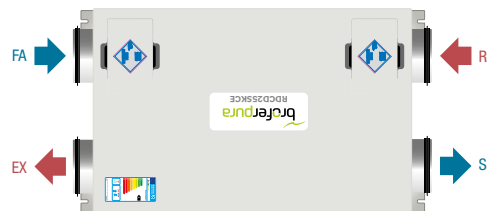

Legenda | Legend

- EX = espulsione | exhaust air
- R = ripresa | return
- FA = aria esterna | fresh air
- S = mandata | supply



DICHIARAZIONE DI PRESTAZIONE DELL'UNITÀ DI RECUPERO DEL CALORE
DECLARATION OF PERFORMANCE HEAT RECOVERY UNIT

Nome o denominazione commerciale del fabbricante Supplier name or trade mark	BROFER								
Identificativo del modello del fornitore e opzioni installate Supplier Model Identifier and options installed	RDCD25SKCE + 4BRF			RDCD25SKCE + RHRF / CO2RF			RDCD25SKCE + RHRF / CO2RF locali-local		
Clima di riferimento Reference climate	Temperato Temperate	Freddo Cold	Caldo Hot	Temperato Temperate	Freddo Cold	Caldo Hot	Temperato Temperate	Freddo Cold	Caldo Hot
SEC in [kWh/(m ² a)] per ogni tipo di clima (temperato, caldo, freddo) for each type of climate (temperate, hot, cold)	-34,16	-73,26	-11,77	-37,12	-77,38	-14,06	-40,62	-82,44	-16,67
SEC Class	A	A+	E	A	A+	E	A	A+	E
Tipologia dichiarata dell'unità di ventilazione Declared Typology	UVR-B Bidirezionale UVR-B Bidirectional			UVR-B Bidirezionale UVR-B Bidirectional			UVR-B Bidirezionale UVR-B Bidirectional		
Tipo di azionamento installato Type of drive installed	Azionamento a velocità multiple Multi-speed drive			Velocità variabile Variable speed			Velocità variabile Variable speed		
Tipo di sistema di recupero del calore Type of heat recovery	a recupero Recuperative			a recupero Recuperative			a recupero Recuperative		
Efficienza termica ¹ Thermal efficiency ¹	74,5%			74,5%			74,5%		
Portata massima in [m ³ /h] ² Maximum flow rate in [m ³ /h] ²	160			160			160		
Potenza elettrica complessiva massima portata [W] Maximum electric Power in [W]	60			60			60		
Livello di potenza sonora (LWA) in [dB(A)] ³ Sound Power Level (LWA) in [dB(A)] ³	39			39			39		
Portata di riferimento in [m ³ /h] ⁴ Reference flow rate [m ³ /h] ⁴	112			112			112		
Differenze di pressione di riferimento [Pa] Reference pressure difference in [Pa]	50			50			50		
SPI in [W/m ³ /h] ⁵	0,21			0,21			0,21		
Fattore di controllo e tipologia Control factor and typology	1			0,85			0,65		
Percentuale massima di trafileamento interno [%] ⁶ Declared maximum internal leakage [%] ⁶	1,2			1,2			1,2		
Percentuale massima di trafileamento esterno [%] ⁶ Declared maximum external leakage [%] ⁶	2,5			2,5			2,5		
Indirizzo Internet con costruzioni Internet address for pre/dis-assembly instruction	www.broferpura.it								







- 1: Efficienza in conformità a EN13141-7:2010 alla portata di riferimento a 50 Pa | Efficiency according EN13141-7:2010 at reference flow at 50 Pa
2: Portata massima a 100 Pa di pressione esterna | Maximum flow at 100 Pa external pressure
3: Irraggiamento dalla cassa alla portata di riferimento a 50 Pa di pressione esterna | Casing radiation at reference flow rate at 50 Pa external pressure
4: La percentuale della portata di riferimento è del 70% della portata massima a 50 Pa di pressione esterna in conformità a EN13141-7:2010
Reference flow rate is 70% of maximum flow at 50 Pa external pressure according EN13141-7:2010
5: In conformità a EN13141-7:2010 alla portata di riferimento | According EN13141-7:2010 at reference flow rate
6: In conformità a EN13141-7:2010 | According EN13141-7:2010
SEC: Consumo energetico specifico | Specific Energy Consumption

RDCD25SKCE

CODICI | CODES

Modello Model	Descrizione Description
RDCD25SKCE	
RDCD25SKCEBE*	
KFTR060A	Kit filtri ricambio (2 pz) efficienza G4 Replacement filter kit (2 pcs) efficiency G4
FTRLET483	Filtro ricambio efficienza F7 Replacement filter efficiency F7

* Versione con batteria elettrica interna all'unità | Version with electric battery inside the unit

	4BRF	RHRF	CO2RF	MODBUSRF	APPRF	DSPRF
Modello Model						
Controllo velocità Speed control	●	●	●		●	●
By-pass	●	●	●		●	●
Antigelo Defrost protection	●	●	●		●	●
Intasamento filtri Clogged filters	●	●	●		●	●
Controllo umidità Humidity control		●				
Controllo CO ₂ CO ₂ control			●			
Funzione booster Booster function	●				●	●
Trasmettitore MODBUS MODBUS gate way				●	●	
Impostazione velocità Speeds setting						●
ON/OFF						●
Allarmi puntuali Punctual alarms	●	●	●			●

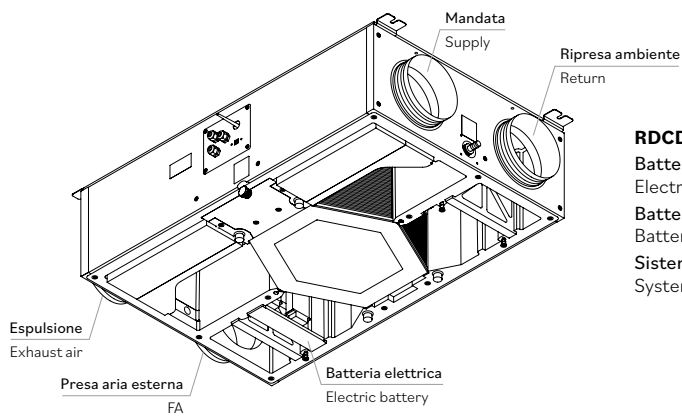

ACCESSORI | ACCESSORIES**RDCD25SKCBE - RDCD25SKCEBE**

Batteria elettrica 1 kw - 230 V - 50 Hz integrata nell'unità
Electric battery 1 kw - 230 V - 50 Hz integrated in the unit

Batteria controllata dalla PCB dell'unità
Battery controlled by PCB of the unit

Sistema non fornibile dopo consegna unità
System not available after unit delivery