

RDCD50SH

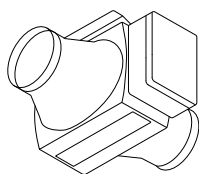

Optional - ECOFILTRO PLUS

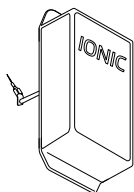

Optional - IONIC

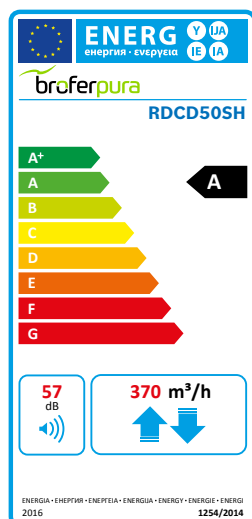

4BRF



UNITATE DE RECUPERARE CĂLDURĂ SISTEM CENTRALIZAT PENTRU UZ DOMESTIC, CU EFICIENȚĂ FOARTE RIDICATĂ INCLUSIV SISTEM DE CONTROL “PLUG AND PLAY”, WIRELESS BY-PASS AUTOMAT INCLUS

Recuperare de căldură: schimbător de căldură în contracurent executat în întregime din material plastic.

Structură: corp autoportant din EPS, cu panouri din otel vopsite, cu filtre și racord condens.

Ventilator: plug fan cu motor EC fără perii.

Filtre: unitățile sunt echipate cu filtre standard din material sintetic eficiență G4, opțional F7 pentru filtrul de aer proaspăt.

DOMESTIC CENTRALIZED HEAT RECOVERY UNIT WITH VERY HIGH EFFICIENCY AND WITH WIRELESS PLUG AND PLAY CONTROL SYSTEM INCLUDED AUTOMATIC BY-PASS INCLUDED

Heat recovery: heat exchanger of the type in countercurrent entirely made of plastic material.

Structure: free standing EPS seal with outer coat painted steel complete of filters extraction system and drain condensate.

Fans: plug fan type with EC Brushless engine.

Filters: the units are equipped with standard filter cells synthetic fiber efficiency G4, optional F7 efficiency on fresh air.

Debit de aer nominal (mc/h) Nominal air flow (mc/h)	370
Presiune statică utilă (Pa) Useful static pressure (pa)	100

VENTILATOARE (DATE PENTRU FIECARE VENTILATOR) | FANS (DATA FOR EACH FAN)

Putere instalată (W) Installed power (W)	83
Curent (A) Current (A)	0,75
Tensiune alimentare (V) Rated voltage (V)	230
Frecvență (HZ) Frequency (HZ)	50
Viteze (nr) Speed (nr)	3+(1 booster)

FILTRE | FILTERS

Eficiență Efficiency Standard	G4 ISO COARSE > 65 %
Eficiență Efficiency Optional	F7 ISO e PM1 > 65 %

DESENE | DRAWINGS

GREUTATE | WEIGHT: 41 kg

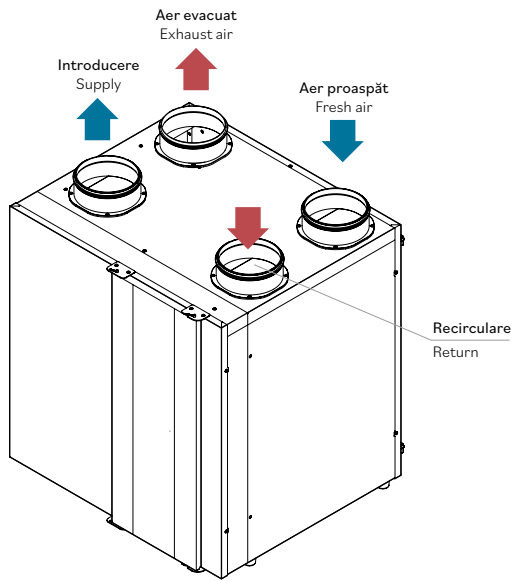

Vedere din față | Front view

Vedere laterală | Side view

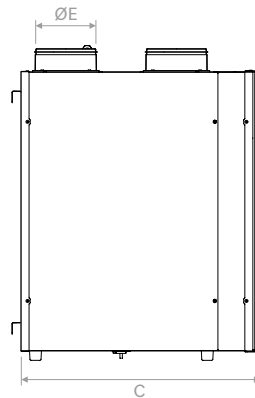
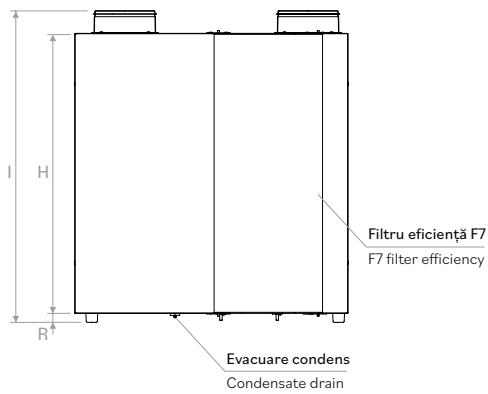

Vedere de sus | Top view

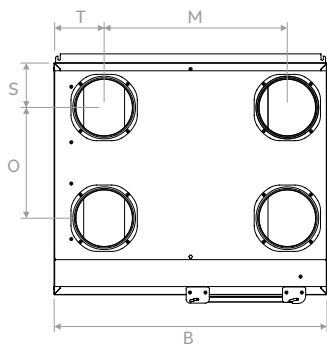

	B	C	H	ØE	I	M	O	R	S	T
mm	702	617	722	160	808	475	287	24	199	128



PERFORMANȚĂ CERTIFICATĂ CONFORM EN 13141:7:2011 | PERFORMANCE EN 13141:7:2011 CERTIFIED

Presiune statică utilă
Useful static pressure
① ③

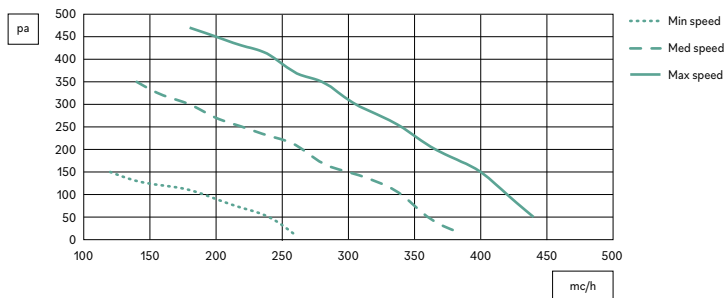

S.F.P.
②

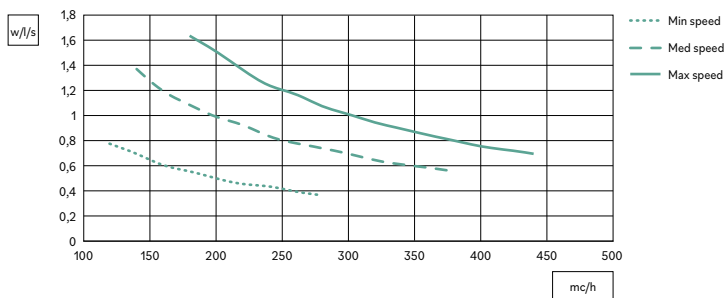

SCHIMBĂTOR DE CALDURĂ CERTIFICAT EN 308 | HEAT EXCHANGER EN 308 CERTIFIED

Diagramă eficiență vara
Aer proaspăt: 32 °C / 50 % R.H.
Aer evacuat: 26 °C / 50 % R.H.
Summer efficiency chart
Fresh air: 32 °C / 50 % R.H.
Return air: 26 °C / 50 % R.H.

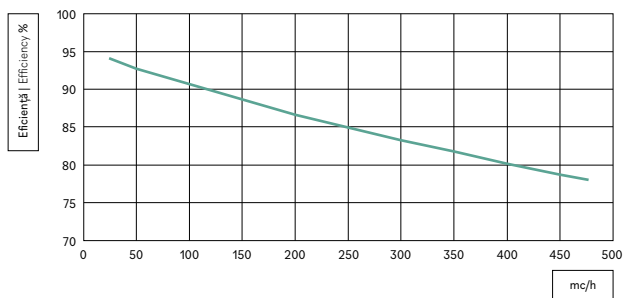

Diagramă eficiență iarna
Aer proaspăt: -5 °C / 80 % R.H.
Aer evacuat: 20 °C / 50 % R.H.
Winter efficiency chart
Fresh air: -5 °C / 80 % R.H.
Return air: 20 °C / 50 % R.H.

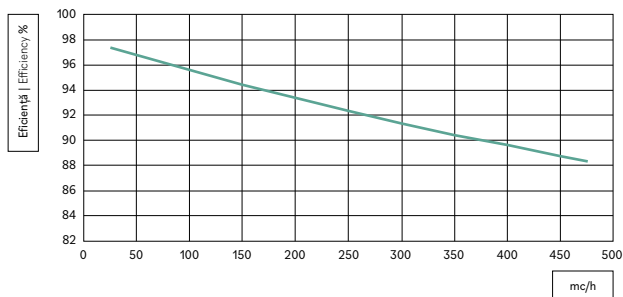

① Date cu filtru standard G4 | Data with standard G4 filters
 ② Date pentru un singur ventilator | Data for single fan
 ③ Pierdere de presiune aer cu filtru eficiență F7, 80 Pa la debit maxim cu filtrul curat
 Air pressure drop with F7 efficiency filter 80 pa at maximum air flow rate with clean filter



NIVEL SONOR RADIAT | RADIATED SOUND LEVEL

VITEZĂ SPEED		PRESIUNE SONORĂ SOUND PRESSURE							
Hz	63	125	250	500	1000	2000	4000	8000	
10V	24	30	48	52	50	47	41	40	dB (A)
8V	21	32	47	51	47	45	39	37	dB (A)
6V	21	28	46	45	38	38	32	27	dB (A)



DECLARAȚIE DE PERFORMANȚĂ A UNITĂȚII DE RECUPERARE CĂLDURĂ

DECLARATION OF PERFORMANCE HEAT RECOVERY UNIT

Nume fabricant sau denumire comercială Supplier name or trade mark	BROFER								
Codul furnizorului și accesoriile instalate Supplier Model Identifier and options installed	RDCD50SH + 4BRF			RDCD50SH + RHRF / CO2RF			RDCD50SH + RHRF / CO2RF local-local		
Climat de referință Reference climate	Temperat Temperate	Rece Cold	Cald Hot	Temperat Temperate	Rece Cold	Cald Hot	Temperat Temperate	Rece Cold	Cald Hot
SEC in [kWh/(m ² a)] pentru fiecare tip de climat (temperat, cald, rece) for each type of climate (temperate, hot, cold)	-37,41	-76	-12,67	-40,12	-79,15	-15,14	-43,16	-82,77	-17,74
SEC Class	A	A+	F	A	A+	F	A	A+	E
Tipologie declarată Declared Typology	UVR-B Bidirecțional UVR-B Bidirectional			UVR-B Bidirecțional UVR-B Bidirectional			UVR-B Bidirecțional UVR-B Bidirectional		
Tipul de ventilator instalat Type of drive installed	Ventilator cu mai multe viteze Multi-speed drive			Viteză variabilă Variable speed			Viteză variabilă Variable speed		
Tipul de recuperare de căldură Type of heat recovery	Recuperativ Recuperative			Recuperativ Recuperative			Recuperativ Recuperative		
Eficiență termică ¹ Thermal efficiency ¹	90,5			90,5			90,5		
Debit maxim de aer [m ³ /h] ² Maximum flow rate in [m ³ /h] ²	370			370			370		
Putere maximă [W] Maximum electric Power in [W]	169			169			169		
Nivel putere sonoră (LWA) în [dB(A)] ³ Sound Power Level (LWA) in [dB(A)] ³	57,3			57,3			57,3		
Debit de referință [m ³ /h] ⁴ Reference flow rate [m ³ /h] ⁴	259			259			259		
Presiune de referință în [Pa] Reference pressure difference in [Pa]	50			50			50		
SPI in [W/m ³ /h] ⁵	0,259			0,259			0,259		
Factor de control și tipologie Control factor and typology	1			0,85			0,65		
Grad de neetanșitate internă maximă declarată [%] ⁶ Declared maximum internal leakage [%] ⁶	0,3			0,3			0,3		
Grad de neetanșitate exterioară maximă declarată [%] ⁶ Declared maximum external leakage [%] ⁶	0,4			0,4			0,4		
SEC - Climă temperată - (kWh electricitate/an) SEC Tempertate climate (kWh electricity/annum)	359			272			178		
AHS (kWh energie primară/an) AHS (kWh primary energy/annum)	4.598	8.995	2.079	4.653	9.083	2.100	4.704	9.202	2.127
Adresa Web pentru instrucțiuni de folosire Internet address for pre/dis-assembly instruction	www.broferpura.it								

- 1: Eficiență conform EN13141-7:2010 la debitul nominal și 50 Pa | Efficiency according EN13141-7:2010 at reference flow at 50 Pa
2: Debit maxim la presiune externă 100 Pa | Maximum flow at 100 Pa external pressure
3: Zgomot radiat de carcasa la debitul nominal și presiune externă 50 Pa | Casing radiation at reference flow rate at 50 Pa external pressure
4: Debitul de referință este 70% din debitul maxim la 50 Pa presiune externă, conform EN13141-7:2010
Reference flow rate is 70% of maximum flow at 50 Pa external pressure according EN13141-7:2010
5: Conform EN13141-7:2010 la debitul nominal | According EN13141-7:2010 at reference flow rate
6: Conform EN13141-7:2010 | According EN13141-7:2010
SEC: CConsum specific de energie | Specific Energy Consumption









PREȚURI | PRICES

Model Model	Descriere Description	€
RDCD50SH		
RDCD50SHE*		
RDCD50SHI**	Dimensiuni Sizes pag. 214	
FTRSV23	Kit filtru de schimb (2 buc) eficiență G4 Replacement filter kit (2 pcs) efficiency G4	
FTRSV48	Filtru de schimb eficiență F7 Replacement filter efficiency F7	

* Versiune cu schimbător entalpic | Version with enthalpic heat exchanger

** Versiune completă cu ionizator IONIC | Version complete with IONIC ionizer

	4BRF	RHRF	CO2RF	MODBUSRF	APPRF	DSPRF
Model Model						
Control viteze Speed control	●	●	●		●	●
By-pass	●	●	●		●	●
Protecție îngheț Defrost protection	●	●	●		●	●
Filtre colmatate Clogged filters	●	●	●		●	●
Control umiditate Humidity control		●				
Control CO ₂ CO ₂ control			●			
Funcție booster Booster function	●				●	●
Ieșire MODBUS MODBUS gate way				●	●	
Selectare viteze Speeds setting						●
ON/OFF						●
Alarmer punctuale Punctual alarms	●	●	●			●

€ inclus în preț
 included in the price

